

SIRUBA[®] Sew Reach

使用説明書

INSTRUCTION BOOK

■ **LKS-1900AN**



CE

為了安全地使用縫紉機

TO ENSURE SAFE USE OF YOUR SEWING MACHINE



由於縫製作業的具體情況，有時不得不靠近機器轉動的零部件進行操作而有可能接觸到轉動零部件，因此實際操作機器的操作員和維修保養的維修人員，必須在事前仔細閱讀有關安全的注意事項，充分理解內容之後再進行操作。此有關安全的注意事項中記述的內容有的不是使用者購買的商品規格的內容。

另外，為了能讓用戶充分地理解使用說明書以及產品的警告標籤，特將警告表示分為如下種類。請充分瞭解這些內容，並遵守指示的要求。

For the sewing machine, automatic machine and ancillary devices (hereinafter collectively referred to as "machine"), it is inevitable to conduct sewing work near moving parts of the machine. This means that there is always a possibility of unintentionally coming in contact with the moving parts. Operators who actually operate the machine and maintenance personnel who are involved in maintenance and repair of the machine are strongly recommended to carefully read to fully understand the following **SAFETY PRECAUTIONS** before using/maintaining the machine. The content of the **SAFETY PRECAUTIONS** includes items which are not contained in the specifications of your product. The risk indications are classified into the following three different categories to help understand the meaning of the labels. Be sure to fully understand the following description and strictly observe the instructions.

(I) 危險等級的說明



(I) Explanation of risk levels

 危險 DANGER	<p>操作或維修保養機器時，如果當事人、第 3 者操作錯誤或沒有避免該情況，有發生死亡或造成重傷的危險。</p> <p>This indication is given where there is an immediate danger of death or serious injury if the person in charge or any third party mishandles the machine or does not avoid the dangerous situation when operating or maintaining the machine.</p>
 警告 WARNING	<p>操作或維修保養機器時，如果當事人、第 3 者操作錯誤或沒有避免該情況，有發生死亡或造成重傷的潛在可能。</p> <p>This indication is given where there is a potentiality for death or serious injury if the person in charge or any third party mishandles the machine or does not avoid the dangerous situation when operating or maintaining the machine.</p>
 注意 CAUTION	<p>操作或維修保養機器時，如果當事人、第 3 者操作錯誤或沒有避免該情況，有造成中輕傷的可能。</p> <p>This indication is given where there is a danger of medium to minor injury if the person in charge or any third party mishandles the machine or does not avoid the dangerous situation when operating or maintaining the machine.</p>

(II) 警告圖示表示和指示標籤的說明

(II)Explanation of pictorial warning indications and warning labels

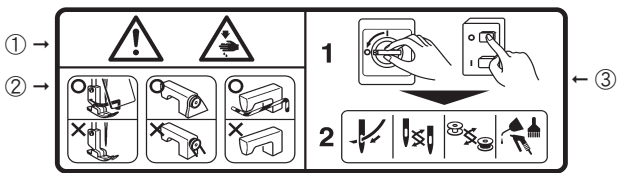
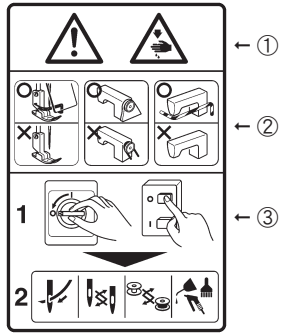
警告圖標表示 Pictorial warning indication		警告圖標表示 Pictorial warning indication	
	有接觸轉動部，造成受傷的危險。 There is a risk of injury if contact-ing a moving section.		作業時拿縫紉機的話，有讓手受傷的危險。 Be aware that holding the sewing machine during operation can hurt your hands.
	有接觸高電壓部，造成觸電的危險。 There is a risk of electrical shock if contacting a high-voltage section.		有捲入皮帶，造成受傷的危險。 There is a risk of entanglement in the belt resulting in injury.
	有接觸高溫部，造成燙傷的危險。 There is a risk of a burn if contacting a high-temperature section.		觸摸了鈕扣傳送器，有受傷的危險。 There is a risk of injury if you touch the button carrier.
	如果直接目視鐳射的話，有傷害眼睛的危險。 Be aware that eye de ciency can be caused by looking directly at the laser beam.	指示標籤 Indication label	
			指示正確的轉動方向。 The correct direction is indicated.
	有頭部接觸到縫紉機的危險。 There is a risk of contact between your head and the sewing machine.		指示地線的連接。 Connection of a earth cable is indicated.

警告標籤 Warning label					
 <p>① →</p> <p>② →</p> <p>← ③</p>	 <p>← ①</p> <p>← ②</p> <p>← ③</p>				
<p>①•有發生中輕度傷害、重傷、死亡的危險。 •觸摸了活動部分的話，有發生受傷的危險。</p> <p>②•應安裝安全防護器，然後再進行縫製。 •應安裝安全護罩，然後再進行縫製。 •應安裝保護裝置，然後再進行縫製。</p> <p>③•必須切斷電源之後，再進行「穿線」、「換針」、「更換梭心」以及「加油、清掃」的操作。</p> <p>① There is the possibility that slight to serious injury or death may be caused. • There is the possibility that injury may be caused by touching moving part.</p> <p>② To perform sewing work with safety guard. • To perform sewing work with safety cover.</p> <p>③ To perform sewing work with safety protection device. • Be sure to turn the power OFF before carrying out "machine-head threading", "needle changing", "bobbin changing" or "oiling and cleaning".</p>					
觸電危險標籤 lectrical-shock danger label					
	<table border="1" style="width: 100%;"> <tr> <td style="text-align: center;">⚠ 危險</td> <td style="text-align: center;">⚠ DANGER</td> </tr> <tr> <td>誤觸高壓電、會受傷。 關掉電源超過5分鐘以上，就拆開蓋子。</td> <td>Hazardous voltage will cause injury. Turn off main switch and unplug power cord and wait at least 5 minutes before opening this cover.</td> </tr> </table>	⚠ 危險	⚠ DANGER	誤觸高壓電、會受傷。 關掉電源超過5分鐘以上，就拆開蓋子。	Hazardous voltage will cause injury. Turn off main switch and unplug power cord and wait at least 5 minutes before opening this cover.
⚠ 危險	⚠ DANGER				
誤觸高壓電、會受傷。 關掉電源超過5分鐘以上，就拆開蓋子。	Hazardous voltage will cause injury. Turn off main switch and unplug power cord and wait at least 5 minutes before opening this cover.				

有關安全的注意事項

SAFETY PRECAUTIONS

•危險

事故：是指給與人身以及財產帶來損害。

1. 需要打開電氣箱時，為了防止觸電事故，請關閉電源，經過 5 分鐘以上的時間之後再打開電氣箱蓋。

•注意

(1)基本注意事項

1. 使用之前，請您一定要閱讀使用說明書以及附屬的所有說明資料。另外，請您妥善保管本使用說明書，以便隨時可以立即查閱。
2. 本注意事項中有部分內容可能不是您所購買的機器規格的內容。
3. 為了防止斷針造成的事故，請戴上安全防護眼鏡進行操作。
4. 使用心臟起搏器的人，請一定要與專門醫生諮詢之後再使用。

(2)安全裝置、警告標籤

1. 為了防止由於沒有安裝安全裝置而造成的事故，操作本機器時，請確認安全裝置是否正確地安裝到規定位置之後再進行操作。
2. 為了防止人身事故，卸下了安全裝置後，請一定再安裝到原來的位置，並確認功能是否正常。
3. 為了防止人身事故，請把警告標籤時常地粘貼到可以明顯看到的機器上。如果脫落或發生汙損，請立即更換成新的標籤。

•DANGER

Accident means "to cause personal injury or death or damage to property."

1. When it is necessary to open the control box containing electrical parts, be sure to turn the power off and wait for five minutes or more before opening the cover in order to prevent accident leading to electrical shock.

•CAUTION

(1)Basic precaution

1. Be sure to read the instruction manual and other explanatory documents supplied with accessories of the machine before using the machine. Carefully keep the instruction manual and the explanatory documents at hand for quick reference.
2. The content of this section includes items which are not contained in the specifications of your product.
3. Be sure to wear safety goggles to protect against accident caused by needle breakage.
4. Those who use a heart pacer have to use the machine after consultation with a medical specialist.

(2)Safety devices and warning labels

1. Be sure to operate the machine after verifying that safety device(s) is correctly installed in place and works normally in order to prevent accident caused by lack of the device(s).
2. If any of the safety devices is removed, be sure to replace it and verify that it works normally in order to prevent accident that can result in personal injury or death.
3. Be sure to keep the warning labels adhered on the machine clearly visible in order to prevent accident that can result in personal injury or death. If any of the labels has stained or come unstuck, be sure to change it with a new one.

(3)用途、改裝

1. 為了防止人身事故，請不要將本機器使用於本來的用途和使用說明書規定的使用方法以外的用處。如果使用於規定用途以外時，本公司一概不負任何責任。
2. 為了防止人身事故，請不要改裝機器。對於因改裝而發生的事故，本公司一概不負任何責任。

(4)教育培訓

1. 為了防止由於不熟練而造成的事故，雇用單位應就有關本機器的操作和安全注意事項，對操作人員進行教育，而且只讓具有專業知識和操作技能的操作人員使用本機器。同時，雇用單位一定事前編制操作人員的教育培訓計畫，並切實地實施。

(5)必須關閉電源的事項

關閉電源：是指關閉電源開關之後，並且把電源插頭從電源插座上拔下來。以下相同。

1. 為了防止人身事故，當確認了異常、故障後以及停電時，請立即關閉電源。
2. 為了防止因機器突然啟動造成的事故，在如下情況時，請一定關閉電源之後再進行操作。特別是使用離合馬達時，關閉電源後，一定確認了縫紉機完全停止轉動之後再進行操作。

(3)Application and modification

1. Never use the machine for any application other than its intended one and in any manner other than that prescribed in the instruction manual in order to prevent accident that can result in personal injury or death. SIRUBA assumes no responsibility for damages or personal injury or death resulting from the use of the machine for any application other than the intended one.
2. Never modify and alter the machine in order to prevent accident that can result in personal injury or death. SIRUBA assumes no responsibility for damages or personal injury or death resulting from the machine which has been modified or altered.

(4)Education and training

1. In order to prevent accident resulting from unfamiliarity with the machine, the machine has to be used only by the operator who has been trained/educated by the employer with respect to the machine operation and how to operate the machine with safety to acquire adequate knowledge and operation skill. To ensure the above, the employer has to establish an education/training plan for the operators and educate/train them beforehand.

(5)Items for which the power to the machine has to be turned off

Turning the power off: Turning the power switch off, then removing the power plug from the outlet. This applies to the following.

1. Be sure to immediately turn the power off if any abnormality or failure is found or in the case of power failure in order to protect against accident that can result in personal injury or death.
2. To protect against accident resulting from abrupt start of the machine, be sure to carry out the following operations after turning the power off. For the machine incorporating a clutch motor, in particular, be sure to carry out the following operations after turning the power off and verifying that the machine stops completely.

- 2-1. 例如，向機針、彎針、分線器等需要穿線的零件進行穿線或更換梭心時。
- 2-2. 例如，更換或調整組成機器的所有零部件時。
- 2-3. 例如，檢查、修理、清掃機器時，或離開機器時。
3. 為了防止觸電、漏電、火災事故，拔電源插頭時，一定要手持插頭拔電線，而不能拉著電線拔。
4. 不使用縫紉機閒放時，一定要關閉電源。
5. 為了防止因電氣零部件的損壞造成的事故，停電後請一定關閉電源。

- 2-1. For example, threading the parts such as the needle, looper, spreader etc. which have to be threaded, or changing the bobbin.
- 2-2. For example, changing or adjusting all component parts of the machine.
- 2-3. For example, when inspecting, repairing or cleaning the machine or leaving the machine.
3. Be sure to remove the power plug by holding the plug section instead of the cord section in order to prevent electrical-shock, earth-leakage or fire accident.
4. Be sure to turn the power off whenever the machine is left unattended between works.
5. Be sure to turn the power off in the case of power failure in order to prevent accident resulting of breakage of electrical components.

在各使用階段的注意事項

PRECAUTIONS TO BE TAKEN IN VARIOUS OPERATION STAGES

(1)搬 運

1. 為了防止人身事故，抬起縫紉機移動時，請一定根據機器的重量採用確保安全的方法進行搬運。另外，有關機器重量，請確認使用說明書的說明。
2. 為了防止人身事故，抬起縫紉機移動時，請採取確保安全的措施防止翻倒、掉落。
3. 為了防止不可預想的事故、掉落事故、機器損壞，請不要再次包裝已經開箱的機器進行搬運。

(2)開 箱

1. 為了防止人身事故，開箱時請按照從上方開始的順序進行開箱。木框包裝時，請一定要小心不要被釘子紮破。請把釘子從木板上拔下來。
2. 為了防止人身事故，取出機器時，請一定首先確認機器的重心位置然後小心地取出。

(1)Transportation

1. Be sure to lift and move the machine in a safe manner taking the machine weight in consideration. Refer to the text of the instruction manual for the mass of the machine.
2. Be sure to take sufficient safety measures to prevent falling or dropping before lifting or moving the machine in order to protect against accident that can result in personal injury or death.
3. Once the machine has been unpacked, never re-pack it for transportation to protect the machine against breakage resulting from unexpected accident or dropping.

(2)Unpacking

1. Be sure to unpack the machine in the prescribed order in order to prevent accident that can result in personal injury or death. In the case the machine is crated, in particular, be sure to carefully check nails. The nails have to be removed.
2. Be sure to check the machine for the position of its center of gravity and take it out from the package carefully in order to prevent accident that can result in personal injury or death.

(3) 安裝

(I) 機台、台腳

1. 為了防止人身事故，請一定使用純正的機台、台腳。不得以使用非純正的零件時，請一定使用可以充分承受機器重量、運轉時的反作用力的機台、台腳。
2. 為了防止人身事故，在台腳上安裝腳輪時，請使用具有充分強度的帶鎖定裝置的腳輪，操作機器時、維修保養、檢查、修理時進行鎖定不要機器晃動。

(II) 電纜、佈線

1. 為了防止觸電、漏電、火災事故，使用電纜時請不要向電纜施加過大的力量。另外，在 V 形皮帶等轉動零部件附近佈設電纜時，已經讓電纜距離它們 30mm 以上。
2. 為了防止觸電、漏電、火災事故，請不要進行分岔佈線。
3. 為了防止觸電、漏電、火災事故，請一定牢固地固定連接器。另外，拔連接器時，請一定手持連接器拔線。

(III) 接地

1. 為了防止因漏電、絕緣耐壓而造成的事故，一定請具有電氣專門知識的人安裝電源插頭。另外，請一定把電源插頭連接到接地的電源插座上。
2. 為了防止因漏電造成的事故，請一定把地線接地。

(IV) 馬達

1. 為了防止馬達燒毀而造成的事故，請一定使用規定的額定馬達 (純正品) 。

(3) Installation

(I) Table and table stand

1. Be sure to use SIRUBA genuine table and table stand in order to prevent accident that can result in personal injury or death. If it is inevitable to use a table and table stand which are not SIRUBA genuine ones, select the table and table stand which are able to support the machine weight and reaction force during operation.
2. If casters are fitted to the table stand, be sure to use the casters with a locking mechanism and lock them to secure the machine during the operation, maintenance, inspection and repair in order to prevent accident that can result in personal injury or death.

(II) Cable and wiring

1. Be sure to prevent an extra force from being applied to the cable during the use in order to prevent electrical-shock, earth-leakage or fire accident. In addition, if it is necessary to cable near the operating section such as the V-belt, be sure to provide a space of 30 mm or more between the operating section and the cable.
2. Be sure to avoid starburst connection in order to prevent electrical-shock, earth-leakage or fire accident.
3. Be sure to securely connect the connectors in order to prevent electrical-shock, earth-leakage or fire accident. In addition, be sure to remove the connector while holding its connector section.

(III) Grounding

1. Be sure to have an electrical expert install an appropriate power plug in order to prevent accident caused by earth-leakage or dielectric strength voltage fault. In addition, be sure to connect the power plug to the grounded outlet without exceptions.
2. Be sure to ground the earth cable in order to prevent accident caused by earth leakage.

(IV) Motor

1. Be sure to use the specified rated motor (SIRUBA genuine product) in order to prevent accident caused by burnout.

2. 使用市場出售的離合馬達時，因被捲入 V 形皮帶而造成的事故，請一定選用安裝有防止捲入功能的皮帶護罩的離合馬達。

(4)操作前

1. 為了防止人身事故，接通電源之前，請一定確認連接器、電纜等確實沒有損傷、脫落、鬆動。
2. 為了防止人身事故，請不要把手伸到活動的部位。另外，請確認皮帶輪的轉動方向是否與箭頭標記一致。
3. 使用帶腳輪的機台腳時，為了防止突然的起動造成的事故，請一定鎖定腳輪，帶有調節器時，請調節台腳把腳固定好。

(5)操作中

1. 為了防止捲入而造成的事故，操作機器時，請注意不要讓手指、頭髮、衣服靠近皮帶輪、手輪、馬達等轉動部位，也不要將物品放到上面。
2. 為了防止人身事故，接通電源時或機器操作中，請不要把手指靠近機針，也不要把手指伸到挑線桿護罩裡。
3. 縫紉機以高速在進行轉動。為了防止弄傷手，操作中絕對不能讓手靠近彎針、分線器、針桿、旋梭、布切刀等活動部位。另外，更換縫紉機機線時，請關閉電源，確認了縫紉機和馬達均完全停止之後再進行更換。
4. 為了防止人身事故，從機台上拆卸縫紉機時，或者返回安裝到原來的位置時，請注意不要夾到手指。

2. If a commercially available clutch motor is used with the machine, be sure to select one with an entanglement preventive pulley cover in order to protect against being entangled by the V-belt.

(4)Before operation

1. Be sure to make sure that the connectors and cables are free from damage, dropout and looseness before turning the power on in order to prevent accident resulting in personal injury or death.
2. Never put your hand into the moving sections of the machine in order to prevent accident that can result in personal injury or death. In addition, check to be sure that the direction of rotation of the pulley agrees with the arrow shown on pulley.
3. If the table stand with casters is used, be sure to secure the table stand by locking the casters or with adjusters, if provided, in order to protect against accident caused by abrupt start of the machine.

(5)During operation

1. Be sure not to put your fingers, hair or clothing close to the moving sections such as the handwheel, hand pulley and motor or place something near those sections while the machine is in operation in order to prevent accident caused by entanglement that can result in personal injury or death.
2. Be sure not to place your fingers near the surround area of the needle or inside the thread take-up lever cover when turning the power on or while the machine is in operation in order to prevent accident that can result in personal injury or death.
3. The machine runs at a high speed. Never bring your hands near the moving sections such as looper, spreader, needle bar, hook and cloth trimming knife during operation in order to protect your hands against injury. In addition, be sure to turn the power off and check to be sure that the machine completely stops before changing the thread.
4. Be careful not to allow your fingers or any other parts of your body to be caught between the machine and table when removing the machine from or replacing it on the table in order to prevent accident that can result in personal injury or death.

5. 為了防止因突然的起動造成的事故，拆卸皮帶護罩以及 V 形皮帶時，請一定關閉電源，確認了縫紉機和馬達均完全停止之後再進行拆卸。
6. 使用伺服馬達時，機器停止時馬達不發出聲音。為了防止因突然的起動造成的事故，請注意不要忘記關閉電源。
7. 為了防止因過熱造成的火災事故，使用時請不要堵住馬達電源箱的冷卻口。

(6)加 油

1. 請使用純正的機油和純正的潤滑脂向規定部位進行加油和塗抹潤滑脂。
2. 為了防止發炎和膿腫，眼睛、身體上粘附了油時，請立即進行清洗。
3. 為了防止腹瀉、嘔吐，如果誤飲了機油，請立即就醫治療。

(7)維修保養

1. 為了防止因不熟練而造成的事故，有關修理、調整，請一定讓熟悉機器的維修保養技術人員按照使用說明書的說明進行修理和調整。另外，更換零部件時，請一定使用本公司的純正零部件。對於不適當的修理和調整以及使用非純正零部件造成的事故，本公司一概不負任何責任。
2. 為了防止因不熟練而造成的事故以及防止觸電事故，請一定讓具有電氣專門知識的人或委託本公司、代理店的技術人員進行有關電氣的修理和維修（包括佈線）。

5. Be sure to turn the power off and check to be sure that the machine and motor completely stop before removing the belt cover and V-belt in order to prevent accident caused by abrupt start of the machine or motor.
6. If a servomotor is used with the machine, the motor does not produce noise while the machine is at rest. Be sure not to forget to turn the power off in order to prevent accident caused by abrupt start of the motor.
7. Never use the machine with the cooling opening of the motor power box shielded in order to prevent fire accident by overheat.

(6)Lubrication

1. Be sure to use SIRUBA genuine oil and SIRUBA genuine grease to the parts to be lubricated.
2. If the oil adheres on your eye or body, be sure to immediately wash it off in order to prevent inflammation or irritation.
3. If the oil is swallowed unintentionally, be sure to immediately consult a medical doctor in order to prevent diarrhea or vomiting.

(7)Maintenance

1. In prevention of accident caused by unfamiliarity with the machine, repair and adjustment has to be carried out by a service technician who is thoroughly familiar with the machine within the scope defined in the instruction manual. Be sure to use SIRUBA genuine parts when replacing any of the machine parts. SIRUBA assumes no responsibility for any accident caused by improper repair or adjustment or the use of any part other than SIRUBA genuine one.
2. In prevention of accident caused by unfamiliarity with the machine or electrical-shock accident, be sure to ask an electrical technician of your company or SIRUBA or distributor in your area for repair and maintenance (including wiring) of electrical components.

3. 為了防止因突然的起動造成的事故，修理和維修保養使用氣缸等高壓空氣的機器時，請一定卸下空氣供給源的管子，排出殘留的空氣之後再進行修理和維修保養。
4. 為了防止人身事故，修理調整和更換零部件後，請一定確認螺絲螺母等沒有鬆動。
5. 機器的使用期間中，請一定定期地進行清掃。此時，為了防止因突然的起動而造成的事故，請一定關閉電源，確認了縫紉機和馬達均完全停止之後再進行清掃。
6. 進行維修保養、檢查、修理時，請一定關閉電源，確認了縫紉機和馬達均完全停止之後再進行操作。(離合馬達時，請注意關閉電源後馬達由於慣性仍然回繼續轉動一定時間。)
7. 為了防止人身事故，經過修理調整，機器不能正常操作時，請立即停止操作，與本公司或代理店聯繫，委託有關技術人員修理。
8. 為了防止人身事故，保險絲熔斷後，請一定切斷電源，排除了保險絲熔斷的原因之後，更換相同規格的新保險絲。
9. 為了防止馬達的火災事故，請定期地進行風扇通氣口的清掃和配線四周的檢查。

(8)使用環境

1. 為了防止因誤動作造成的事故，請在沒有高頻電焊機等強噪音源(電磁波)影響的環境下使用縫紉機。

3. When carrying out repair or maintenance of the machine which uses air-driven parts such as an air cylinder, be sure to remove the air supply pipe to expel air remaining in the machine before hand, in order to prevent accident caused by abrupt start of the air-driven parts.
4. Be sure to check that screws and nuts are free from looseness after completion of repair, adjustment and part replacement.
5. Be sure to periodically clean up the machine during its duration of use. Be sure to turn the power off and verify that the machine and motor stop completely before cleaning the machine in order to prevent accident caused by abrupt start of the machine or motor.
6. Be sure to turn the power off and verify that the machine and motor stop completely before carrying out maintenance, inspection or repair of the machine. (For the machine with a clutch motor, the motor will keep running for a while by inertia even after turning the power off. So, be careful.)
7. If the machine cannot be normally operated after repair or adjustment, immediately stop operation and contact SIRUBA or the distributor in your area for repair in order to prevent accident that can result in personal injury or death.
8. If the fuse has blown, be sure to turn the power off and eliminate the cause of blowing of the fuse and replace the blown fuse with a new one in order to prevent accident that can result in personal injury or death.
9. Be sure to periodically clean up the air vent of the fan and inspect the area around the wiring in order to prevent fire accident of the motor.

(8)Operating environment

1. Be sure to use the machine under the environment which is not affected by strong noise source (electro-magnetic waves) such as a high-frequency welder in order to prevent accident caused by malfunction of the machine.

2. 為了防止因誤動作造成的事故，在超過額定電壓 $\pm 10\%$ 的地方，請不要使用縫紉機。
 3. 為了防止因誤動作造成的事故，對於使用氣缸等高壓空氣的裝置，請確認了壓力符合規定之後再進行使用。
 4. 為了安全地使用縫紉機，請一定在下列環境下進行使用。
動作時的周圍溫度 $5^{\circ}\text{C} \sim 35^{\circ}\text{C}$
動作時的相對濕度 $35\% \sim 85\%$
 5. 為了防止因電氣零部件的損壞和誤動作造成的事故，從寒冷的環境急速地變到溫暖的地方後容易產生結露現象，請等待水滴完全乾燥之後再接通電源。
 6. 為了防止因電氣零部件的損壞和誤動作造成的事故，打雷時為了安全，請停止操作，並拔下電源插頭。
 7. 有的電波狀態下，可能會給予附近的電視機、收音機帶來噪音。此時，請在稍稍離開縫紉機的地方使用電視機、收音機。
 8. 為了確保作業環境，請遵守各國的有關法令。需要對應噪音時，請穿戴有關法令規定的防音防護用具等。
 9. 有關產品、包裝的廢棄，使用完的潤滑油等的處理，請按照各國的法律法規進行適當的處理。
2. Never operate the machine in any place where the voltage fluctuates by more than "rated voltage $\pm 10\%$ " in order to prevent accident caused by malfunction of the machine.
 3. Be sure to verify that the air-driven device such as an air cylinder operates at the specified air pressure before using it in order to prevent accident caused by malfunction of the machine.
 4. To use the machine with safety, be sure to use it under the environment which satisfies the following conditions:
Ambient temperature during operation 5°C to 35°C .
Relative humidity during operation 35% to 85% .
 5. Dew condensation can occur if bringing the machine suddenly from a cold environment to a warm one. So, be sure to turn the power on after having waited for a sufficient period of time until there is no sign of water droplet in order to prevent accident caused by breakage or malfunction of the electrical components.
 6. Be sure to stop operation when lightning flashes for the sake of safety and remove the power plug in order to prevent accident caused by breakage or malfunction of the electrical components.
 7. Depending on the radio wave signal condition, the machine may generate noise in the TV or radio. If this occurs, use the TV or radio with kept well away from the machine.
 8. In order to ensure the work environment, local laws and regulations in the country where the sewing machine is installed shall be followed. In the case the noise control is necessary, an ear protector or other protective gear should be worn according to the applicable laws and regulations.
 9. Disposal of products and packages and treatment of used lubricating oil should be carried out properly according to the relevant laws of the country in which the sewing machine is used.

為了安全地使用 LKS-1900AN 縫紉機的注意事項

PRECAUTIONS TO BE TAKEN SO AS TO USE THE LKS-1900AN SERIES MORE SAFELY

•危險

1. 為了防止觸電事故，請不要在接通電源的狀態下打開馬達電氣箱的蓋子或觸摸電氣箱內的零件。
2. 變更圖案後，請確認落針位置。萬一圖案突出壓腳，縫製中機針會碰到壓腳，發生危險的斷針事故。
3. 機針落下的狀態請不要關閉電源。有可能挑線桿弄斷機針。

•DANGER

1. To avoid electrical shock hazards, neither open the cover of the electrical box for the motor nor touch the components mounted inside the electrical box.
2. After changing the pattern, make sure the needle entry point. If the pattern is protruded from the work clamp feet, the needle will interfere with the work clamp feet during sewing, and it is dangerous due to the needle breakage or the like.
3. Do not turn OFF the power in a state that the needle is lowered. Wiper may break the needle.

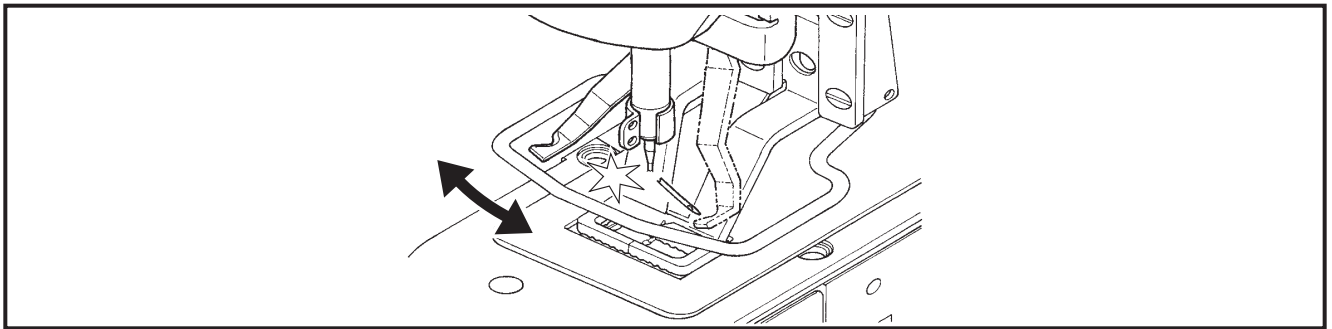

•注意

1. 打開（ON）電源開關後，操作盤上什麼也不顯示時，請關閉（OFF）電源開關，然後確認電源電壓和電源規格。
2. 為了防止人身傷害，接通電源開關時以及縫紉機運轉中，請不要把手指伸到挑線桿、布壓腳、布壓腳機構部、挑線桿護罩中、切布刀以及機針下面。
3. 為了防止突然的起動造成人身事故，放倒縫紉機時，拆卸馬達外罩時，請關掉電源。
4. 為了防止被捲入的人身事故的發生，繞線時請確認了機針下沒有障礙物之後再踩起動開關。另外，切線動作中，請不要讓頭髮靠近機器。

•CAUTION

1. In case nothing is displayed in the operation panel even when the power switch is turned ON, turn OFF the power switch and check the power voltage and phase.
2. To prevent personal injury or death, never put finger into the thread take-up lever, work clamp, work clamp mechanism and thread take-up cover, and under or near the cloth cutting knife and needle when turning on the power switch or while the machine is in operation.
3. To protect against possible accidents due to abrupt startup of the machine, turn OFF the power switch before tilting the machine head or removing the motor cover.
4. So as to prevent possible accidents caused by abrupt start of the sewing machine, depress the start switch after ascertaining that there is no interfering thing under the needle when winding the bobbin thread. In addition, never put your hair close to the machine during thread trimming.

5. 變更圖案、準備鍵 ON、壓腳開關 ON、中壓腳按鈕 ON、繞線按鈕 ON 時，壓腳自動地下降，為了防止突然的啟動發生的事故，請絕對不要把手指放到壓腳下面。
 6. 為了防止捲入機器的人身事故，縫紉機運轉中請不要把手指、頭髮、衣服靠近馬達、切刀等 驅動部分，也不要將物品放到機器的上面。
 7. 為了防止對人身的傷害，請不要在卸下馬達外罩、護目鏡等安全裝置的狀態下運轉縫紉機。
 8. 為了防止人身傷害，卸下縫紉機各部的護罩的狀態下，請不要運轉縫紉機。
 9. 操作盤上也進行有關安全的警告，打開 (ON) 電源後請確認了機器正常之後再運轉縫紉機。
 10. 為了防止人身傷害，縫紉機運轉中請不要用手按推皮帶飛輪。
 11. 為了防止對人身的傷害，放倒縫紉機時和返回原來位置時，請注意不要夾到手指等。
 12. 為了防止觸電和損壞電氣零件的事故，插拔電源插頭之前請一定關掉電源開關。
 13. 為了防止損壞電氣零件的事故，打雷時，請停止作業，拔下電源插頭，以保證安全。
 14. 為了防止損壞電氣零件的事故，從寒冷的地方移動到暖和的地方等時，容易發生結露現象，所以請待水滴完全乾燥之後再打開電源。
5. Feeding frame automatically comes down when pattern is changed, ready key is ON, Presser switch is ON, intermediate presser button is ON and bobbin winder button is ON. To prevent possible accidents caused by abrupt start of the sewing machine, never place your finger under the feeding frame.
 6. To avoid personal injury, never bring your fingers hair or clothing close to V belt, cloth cutting knife or motor during operation, and never place anything on any of these parts.
 7. To avoid personal injury, never operate the machine with the motor cover, eye protection cover, or any other safety devices removed.
 8. To prevent personal injury or death, do not operate the sewing machine with its covers removed.
 9. The operation panel displays safety warnings. It is necessary therefore to first verify normal display on the panel when the power switch is turned on, before operating the sewing machine.
 10. To prevent personal injury or death, do not press the hand pulley while the sewing machine is in operation.
 11. To avoid personal injury, be careful never to allow your finger to go inside the machine when tilting or raising the machine head.
 12. To prevent possible accidents due to electric shocks or damaged electrical component(s), always turn OFF the power switch before connecting or disconnecting the power plug.
 13. During thunder and lightning storms, stop your work and disconnect the power from the outlet to ensure safety and prevent possible accidents due to damaged electrical component(s).
 14. If the machine is suddenly moved from a cold place to a warm place, dew condensation may result. If this occurs, be sure to confirm that there are no potentially dangerous water drops in the machine before turning it on in order to prevent possible accidents due to damaged electrical component(s).

15. 為了防止損壞電氣零件的事故，停電時，請一定關掉電源。
 16. 本裝置請在工業用環境下使用。在一般家庭裡使用時如果靠近電視機或收音機使用的話，有發生接收不良的故障。
 17. 長時間連續使用縫紉機的話，縫紉機主機的一部分、操作盤背面等有可能有溫度上升到 15°C 左右，感覺到發熱，但是這不是異常，對零部件等沒有影響。
 18. 請不要往機油槽和旋梭以外加縫紉機油。因為本機除旋梭以外採用潤滑脂潤滑，如果加了縫紉機油的話，潤滑脂就會漏瀉出來，造成磨損。
 19. 因為本產品屬於精密機器，所以操作時請充分注意，不要把水、油濺到機器上面，也不要讓機器掉落給與機器衝擊。
 20. 本機器是 A 級工業用機器。在家庭環境下使用此機器的話，有可能發生電波干擾的現象。此時，請使用人採取適當的措施解決電波干擾問題。
 21. 為了防止因漏電、絕緣耐壓問題造成的事故，請讓具有電氣專門知識的人正確地安裝電源插頭。另外，請一定把電源插頭插到連接地線的電源插座上。
 22. 為了防止因漏電造成的事故，請一定將地線接地。
 23. 連接 LKS-1900AN 系列的電氣箱，請一定使用 LKS-1900AN 系列專用的電氣箱。(連接了 LKS-1900AN 系列用的電氣箱的話，有誤動作的危險。)
15. In the event of a power failure, be sure to turn OFF the power to the machine to protect against damaged electrical components.
 16. This sewing machine should be used under industrial environment. Under general house-hold environment, the machine may cause poor reception when used in proximity of the television set or radio.
 17. When the sewing machine is used without a break for many hours, the temperature of a part of the machine body or the rear side of operation panel rises higher by 15°C than the environmental temperature, and you may feel the heat from the part. However, this phenomenon is not abnormal, and does not affect the components or the like.
 18. Do not lubricate the machine oil to the places other than the oil tank and the hook section. The grease lubricating system except the hook section is employed for this sewing machine, and the grease flow out when lubricating the machine oil resulting in worn-out of the components.
 19. Be careful of handling this product so as not to pour water or oil, shock by dropping, and the like since this product is a precision instrument.
 20. This is a Class A product. In a domestic environment this product may cause radio interference, in which case the user may be required to make corrective actions.
 21. In order to prevent possible accidents due to a ground fault or a dielectric voltage, an appropriate power plug should be installed by a person who has expertise in electricity. In addition, the power plug should be connected to the receptacle which is properly grounded without exceptions.
 22. In order to prevent possible accidents due to a ground fault, the earth cable should be properly grounded.
 23. For the control box to be connected to the LKS-1900AN Series, use the exclusive control box for the LKS-1900AN Series. (If the control box for the LKS-1900AN Series is connected to the LKS-1900AN Series sewing machine, a malfunction can be caused.)

關於安全裝置和警告標籤

SAFETY DEVICES AND WARNING LABELS

注意被夾標籤
Warning label against pinching



這表示有把手指等夾進挑線桿的危險。
This label warns that fingers or other parts of human body can be pinched in the thread take-up lever.

警告標籤(參照 ii 頁警告標籤)
Warning label(Refer to the warning label on page ii.)

記載著操作縫紉機時的最低限度的注意事項。
The label gives the minimum precautions to be taken when operating the sewing machine.

挑線桿護罩
Thread take-up lever cover

這是防止人身體和挑線桿接觸的護罩。
This is a cover for preventing contact between the human body and the thread take-up lever.

馬達護罩 Motor cover

這是防止馬達和人身體接觸的護罩。
This is a cover for preventing contact between the human body and the motor.

注意被夾標籤
Warning label against pinching



這表示有把手指夾進縫紉機下面的危險。
This label warns that hands can be pinched under the sewing machine.

護目鏡
Eye protection cover

這是防止因斷針而傷害眼睛的護罩。
This is a cover for protecting eyes from being injured by a broken needle.

手指防護器
Finger guard

這是防止手指和機針接觸的護罩。
This is a cover for preventing contact between fingers and the needle.

電源開關
Power switch

這是切斷縫紉機電源裝置的電源開關。
This is a switch for disconnecting the power unit of the sewing machine from the power supply.

電源開關 (EU 規格)
Power switch (EU type)

這是切斷縫紉機電源裝置的電源開關。同時還兼用緊急停止開關。
This switch is used for disconnecting the power unit of the sewing machine from the power supply. It is also used as the emergency stop switch.

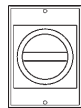

關於電源開關的選定
Selection of the power switch

請使用在額定電流20A以上、短路遮斷容量120A以上的黃色背部具有紅色操作部並符合IEC60204-1標準依據的電源開關。
Use the IEC60204-1-compliant power switch with rated current of 20 A or more and short-circuit breaking capacity of 120 A or more, which has the operating section in red against the yellow background.

觸電危險標籤
(參照 ii 頁觸電危險標籤)
Electrical-shock danger label
(Refer to "Electrical-shock danger label" on page ii.)



EU規格
EU type

記載著為了防止觸電，避免危險的安全注意事項。
In order to protect against electrical shock, safety precautions to be taken to avoid danger are written on this label.

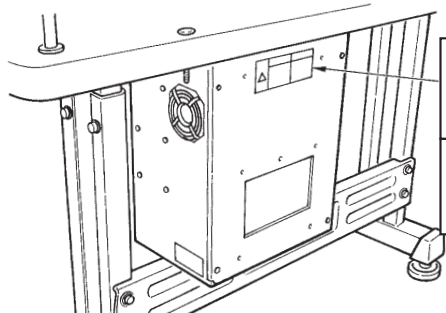
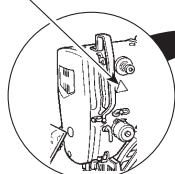

⚠ 注意 CAUTION









- 另外，在使用說明書中為了突出說明的重點，有的地方省略顯示了「護目鏡」、「手指防護器」等安全裝置，請瞭解。但是實際使用時，請絕對不要卸下這些安全裝置。
- In addition, be aware that the safety devices such as the "eye protection cover" and "finger guard" are sometimes omitted in the sketches, illustrations and figures included in the Instruction Manual for the explanation's sake. In the practical use, never remove those safety devices.

索引

INDEX

頁 /PAGE

索引	INDEX	頁 /PAGE
I . LKS-1900AN 高速電子加固縫紉機的說明	I . EXPLANATION OF , LKS-1900AN COMPUTER-CONTROLLED HIGH-SPEED BARTACKING MACHINE .	
[1] 規格	[1] SPECIFICATIONS	1
[2] 各部的名稱	[2] CONFIGURATION	2
1. 主機的名稱	1. NAMES OF MAIN UNIT	2
2. 操作箱開關的名稱和說明	2. NAMES AND EXPLANATION OF SWITCHES ON THE OPERATION PANEL .	3
[3] 安裝	[3] INSTALLATION	5
1. 電氣箱的安裝	1. INSTALLING THE ELECTRICAL BOX	5
2. 連結桿的安裝方法	2. ATTACHING THE CONNECTING ROD	5
3. 機頭部支桿的安裝	3. INSTALLING THE HEAD SUPPORT ROD	6
4. 電源開關的安裝、連接	4. INSTALLING AND CONNECTING THE POWER SWITCH	6
5. 縫紉機的搬運方法	5. HOW TO CARRY THE SEWING MACHINE	8
6. 縫紉機機頭的安裝	6. INSTALLATION OF THE SEWING MACHINE HEAD	8
7. 廢油槽和機頭支撐橡膠的安裝	7. INSTALLING THE DRAIN RECEIVER AND THE HEAD SUPPORT RUBBER	9
8. 安全開關	8. SAFETY SWITCH	9
9. 縫紉機的放倒方法	9. TILTING THE SEWING MACHINE HEAD	10
10. 操作盤的安裝	10. INSTALLING THE OPERATION PANEL	10
11. 電纜線的連接	11. CONNECTING THE CORD	11
12. 電線的處理	12. MANAGING THE CORD	12
13. 護目鏡的安裝	13. INSTALLING THE EYE PROTECTION COVER	13
14. 線架的安裝	14. INSTALLING THE THREAD STAND	13
[4] 縫紉機的準備	[4] OPERATION OF THE SEWING MACHINE	13
1. 加油方法	1. LUBRICATION	13
2. 機針的安裝方法	2. ATTACHING THE NEEDLE	14
3. 上線的穿線方法	3. THREADING THE MACHINE HEAD	15
4. 梭殼的取下插入	4. INSTALLING AND REMOVING THE BOBBIN CASE	15
5. 旋梭的插入方法	5. INSTALLING THE BOBBIN	16
6. 線張力的調整方法	6. ADJUSTING THE THREAD TENSION	16
7. 挑線彈簧的調節	7. ADJUSTING THE THREAD TAKE-UP SPRING	17
8. 縫製張力	8. EXAMPLE OF THE THREAD TENSION	18

索引	INDEX	頁 /PAGE
[5] 縫紉機的操作 (基礎篇)	[5] OPERATION OF THE SEWING MACHINE (BASIC)	19
1. 專案資料的設定	1. ITEM DATA SETTING	19
2. 圖案形狀的確認	2. CHECKING THE CONTOUR OF A SEWING PATTERN	22
3. 縫製	3. SEWING	23
4. 變更為其他圖案	4. CHANGE TO THE OTHER SEWING PATTERN .	24
5. 捲繞底線	5. WINDING A BOBBIN	24
6. 夾線裝置	6. THREAD CLAMP DEVICE	26
[6] 縫紉機的操作 (應用篇)	[6] OPERATION OF THE SEWING MACHINE (ADVANCED)	29
1. 使用圖案鍵 (    ) 進行縫製	1. PERFORMING SEWING USING THE PATTERN KEYS ( ,  ,  ,  AND )	29
2. 使用組合功能 (複合) 的縫製	2. PERFORMING SEWING USING THE COMBINATION FUNCTION	33
3. 使用「底線計數器」的縫製	3. PERFORMING SEWING USING THE “BOBBIN THREAD COUNTER”	36
4. 暫停的使用方法	4. HOW TO USE THE TEMPORARY STOP	37
5. 圖案線張力的設定	5. SETTING THE PATTERN THREAD TENSION	37
6. 使用時的注意	6. CAUTIONS IN OPERATION	39
[7] 維修	[7] MAINTENANCE	40
1. 針桿高度	1. ADJUSTING THE HEIGHT OF THE NEEDLE BAR	40
2. 機針與旋梭	2. ADJUSTING THE NEEDLE-TO-SHUTTLE RELATION .	40
3. 壓腳的高度	3. ADJUSTING THE LIFT OF THE WORK CLAMP FOOT	43
4. 移動刀和固定刀	4. THE MOVING KNIFE AND COUNTER KNIFE .	44
5. 夾線裝置	5. NEEDLE THREAD CLAMP DEVICE	44
6. 挑線桿的調整	6. ADJUSTMENT OF THE WIPER	45
7. 廢油的處理	7. DRAINING WASTE OIL	45
8. 旋梭的加油量	8. AMOUNT OF OIL SUPPLIED TO THE HOOK	46
9. 保險絲的更換	9. REPLACING THE FUSE	46
10. 向指定部位補充潤滑脂	10. REPLENISHING THE DESIGNATED PLACES WITH GREASE	47
[8] 記憶體開關的使用方法	[8] HOW TO USE THE MEMORY SWITCH	49

索引	INDEX	頁 /PAGE
1. 記憶體開關的啟動和變更	1. START AND CHANGE OF THE MEMORY SWITCH .	49
2. 記憶體開關的設定例	2. EXAMPLE OF THE MEMORY SWITCH SETTING	50
3. 記憶體開關功能一覽表	3. TABLE OF FUNCTIONS OF THE MEMORY SWITCH	55
[9] 其他	[9] OTHERS	58
1. 設定開關的設定	1. SETTING THE DIP SWITCH	58
2. 標準圖案規格對應表	2. TABLE OF THE STANDARD PATTERN SPECIFICATION	59
3. 標準圖案一覽表	3. TABLE OF THE STANDARD PATTERNS .	60
4. 壓腳一覽表	4. TABLE OF THE WORK CLAMP FOOT	62
5. LKS-1900AN 數據 ROM	5. LKS-1900AN DATA ROM	64
6. 異常一覽表	6. ERROR LIST	65
7. 縫製時的故障、原因和對策	7. TROUBLES AND CORRECTIVE MEASURES (SEWING CONDITIONS)	68
8. 選購品零件一覽表	8. TABLE OF THE OPTIONAL PARTS	70

[1] 規格

[1] SAFETY INSTRUCTIONS

I . LKS-1900AN 高速電子加固縫紉機的說明

I . EXPLANATION OF LKS-1900AN, COMPUTER-CONTROLLED HIGH-SPEED BARTACKING MACHINE

1	縫製範圍 Sewing area	X (左右) 方向 40mm Y (前後) 方向 30mm X (lateral) direction 40 mm Y (longitudinal) direction 30 mm
2	最高縫紉速度 Max. sewing speed	3,200sti/min ※ (針跡 5.0mm, Y 3.5mm 以下時) 3,200 sti/min ※ (When sewing pitches are less than 5 mm in X-direction and 3.5 mm in Y-direction.)
3	縫跡長度 Stitch length	0.1 ~ 10.0mm (0.1 單位) 0.1 to 10.0 mm (adjustable in 0.1 mm step)
4	壓腳送布 Feed motion of work clamp foot	間斷送布 (步進馬達雙軸驅動方式) Intermittent feed (2-shaft drive by stepping motor)
5	針桿行程 Needle bar stroke	41.2mm
6	使用機針 Needle	DP×5、DP×17
7	壓腳上升量 Lift of work clamp foot	標準 13mm 最大 17mm 13 mm (standard) Max.17 mm
8	旋梭 Shuttle	半旋轉標準旋梭 Standard semi-rotary hook (oil wick lubrication)
9	使用機油 Lubricating oil	No.2 相當於 ISO VG32 (加油方式) New Defrix Oil No. 2 (supplied by oiler)
10	資料的記錄 Data recording	EEPROM (128Kbyte) EPROM (32Kbyte)
11	向右、縮小功能 Enlarging / Reducing facility	X 方向、Y 方向各為 20 ~ 200% (1%為單位) 20% to 200% (1% step) in X direction and Y direction respectively
12	放大、縮小方式 Enlarging / Reducing method	增減縫跡長度方式 Pattern enlargement / reduction can be done by increasing/decreasing the stitch length
13	縫紉速度限制 Max. sewing speed limitation	400 ~ 3,200sti/min ※ (100sti/min 單位) 400 to 3,200 sti/min ※ (100 sti/min steps)
14	圖案選擇功能 Pattern selection	圖案 No. 指定方式 (1 ~ 200) Specifying pattern No. type (1 to 200)
15	底線計數器 Bobbin thread counter	上升/下降方式 (0 ~ 9999) UP/DOWN type (0 to 9999)
16	縫紉機馬達 Sewing machine motor	伺服馬達 Servo motor
17	外形尺寸 Dimensions	W : 1,200mm L : 660mm H : 1,100mm (使用標準機架) W : 1,200 mm L : 660 mm H : 1,100 mm (Use the standard table and stand.)
18	重量 Weight	機頭 42Kg、電氣箱 16.5Kg Machine head 42 kg, Control box 16.5 kg
19	消耗電力 Power consumption	450VA (圖案花樣 No.1、3200sti.min、休止 1 秒) 450 VA (Pattern No. 1, 3,200 sti/min, 1-sec pause time)
20	使用溫度範圍 Operating temperature range	5°C ~ 35°C
21	使用濕度範圍 Operating humidity range	35% ~ 85% (無結露) 35% to 85% (No dew condensation)
22	電源電壓 Line voltage	額定電壓 ±10% 50Hz/60Hz Rated voltage ± 10% 50/60 HZ

※ 最高縫製速度，請根據縫製條件降低速度使用。LKS-1900ANWS (倍旋梭規格) 的最高縫製速度為 2700sti/min。

※ Reduce the max. sewing speed in accordance with the sewing conditions. Max. sewing speed of LKS-1900ANWS (double capacity hook) is 2,700 sti/min.

[2] 各部的名稱

[2] CONFIGURATION

1. 主機的名稱

1. Names of main unit

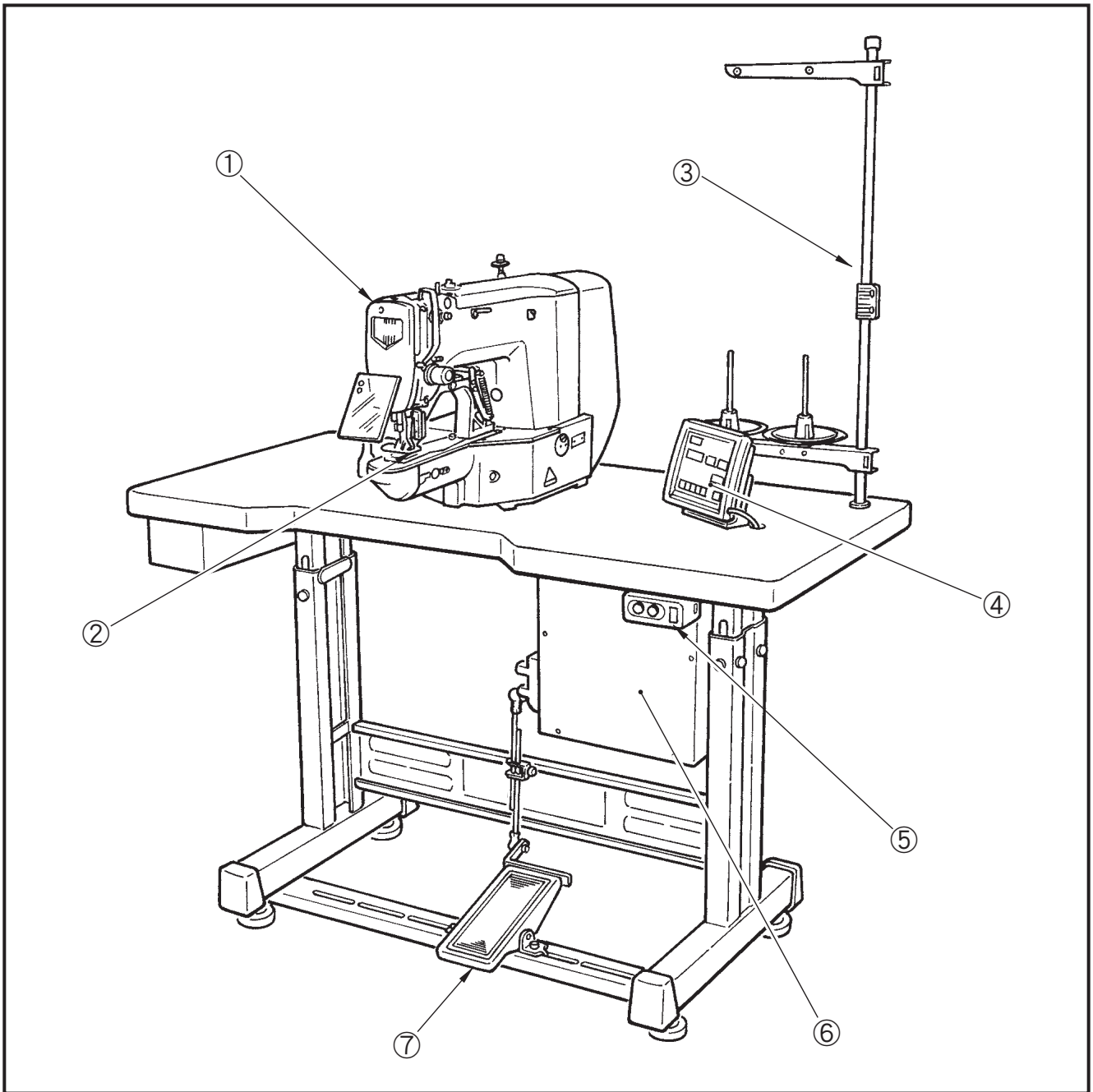

- ① 縫紉機機頭
- ② 布壓腳
- ③ 線架裝置
- ④ 操作盤
- ⑤ 電源開關
- ⑥ 控制箱
- ⑦ 踏板開關







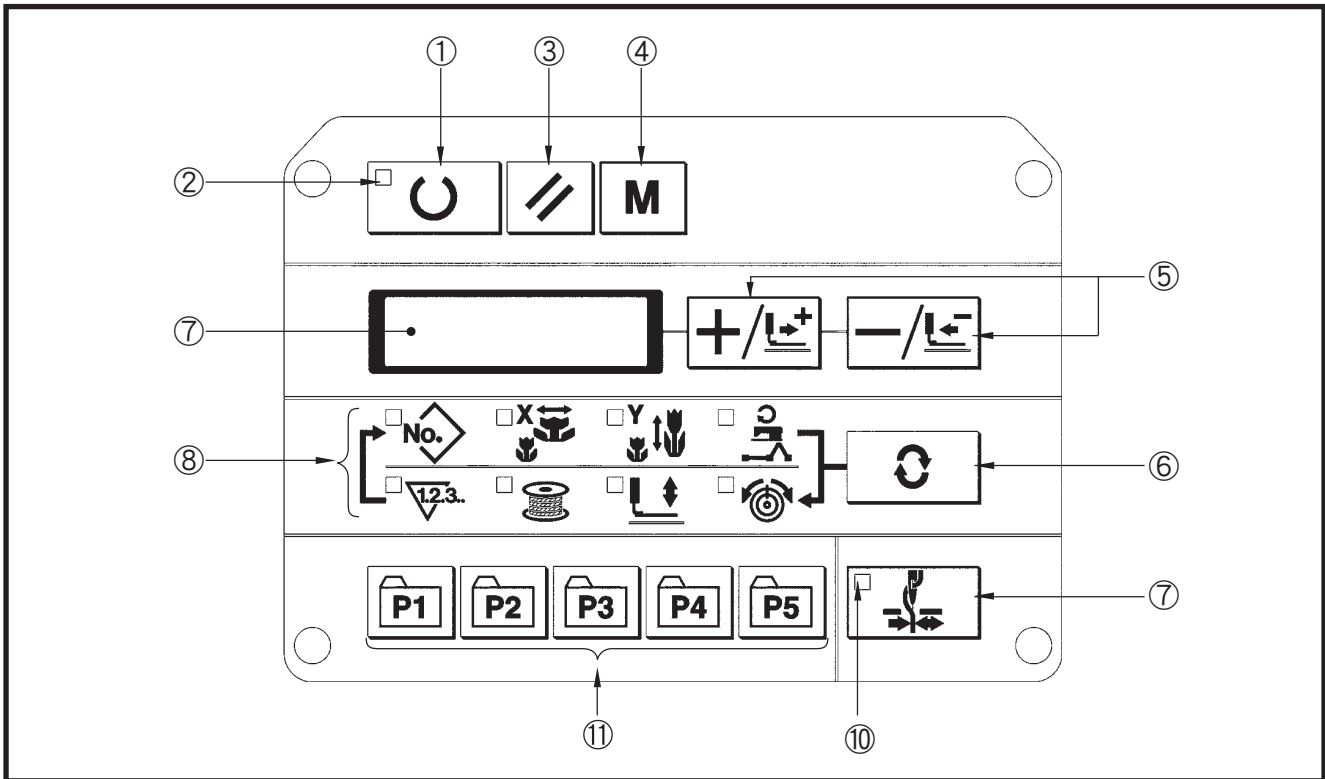

- ① Machine head
- ② Work clamp feet
- ③ Thread stand
- ④ Operation panel
- ⑤ Power switch
- ⑥ Control box
- ⑦ Pedal switch

2. 操作相關的名稱和說明

2. Names and explanation of switches on the operation panel



<p>① 「準備」鍵 「Ready」key</p>	<p>操作盤的設定狀態和縫紉機實際動作的縫製狀態的變換鍵。 This key changes over the setting state from the panel to the sewing state where the sewing machine actually operates.</p>
<p>② 縫製 LED Sewing LED</p>	<p>設定狀態時為滅燈，縫製狀態為亮燈。通過「準備」鍵來變換。 This LED goes off at the time of setting state and lights up at the time of sewing state. Changeover can be performed with 「Ready」key.</p>
<p>③ 「復位」鍵 「Reset」key</p>	<p>解除異常、將設定值返回到初期值等時使用。 This key is used for canceling error or returning the set value to the initial value.</p>
<p>④ 「方式」鍵 「Mode」key</p>	<p>記憶體開關的設定方式。 This key makes the setting mode of the memory switch.</p>
<p>⑤ 「+ / 前進傳送」鍵、 「- / 後退傳送」鍵 「+ / Feed forward」 key and 「- / Feed backward」key</p>	<p>使用於圖案 No.、擴大縮小率的變更、前進 / 後退送布。 This key is used for changing pattern No. and X/ Y scale, and feed forward/feed backward.</p>
<p>⑥ 「選擇」鍵 「Selection」key</p>	<p>選擇設定的項目。被選擇的項目的項目選擇 LED 和設定值被顯示。 This key selects the item to be set. Item selection LED of the selected item and the set value are displayed.</p>
<p>⑦ 資料顯示 LED Data indication LED</p>	<p>顯示圖案 No.、擴大縮小率等為選擇項目的設定值。 This LED indicates the set values of the selected items such as pattern No., X/Y scale, etc.</p>

<p>⑧ 項目選擇 LED Item selection LED</p>	<p>被選擇的項目的 LED 亮燈。 LEDs of the selected items light up.</p> <p>  圖案 No Pattern No.  X 擴大縮小率 X scale  Y 擴大縮小率 X Y scale </p> <p>  縫製計數器 Sewing counter  最高速度限制 Max. speed limitation  線張力 Thread tension </p> <p>  卷線 Bobbin winder  壓腳下降 Work clamp foot lowering </p>
<p>⑨ 夾線 ON/OFF Needle thread clamp ON/OFF key</p>	<p>可以選擇夾線功能的有效 / 無效。有效時，夾線顯示 LED 亮燈。（註 1） This key selects effective/ineffective of needle thread clamp. When it is effective, needle thread clamp display LED lights up. (Note 1)</p>
<p>⑩ 夾線顯示 LED Needle thread clamp display LED</p>	<p>亮燈時，進行夾線動作。 When this LED lights up, needle thread clamp operates.</p>
<p>⑪ 圖案登記鍵 Needle thread clamp display LED</p>	<p>登記圖案。登記後的圖案，只要一按此鍵就可以立即進行縫製。變更擴大縮小率、縫製位置等可以進行登記。 This key registers the pattern. When this key is pressed, the pattern registered here can sew immediately. X/Y scale, sewing position, etc. can be changed and registered.</p>

【註 1】 S-1903AN 標準出貨時，記憶體開關 No.35 設定為禁止（不動作）夾線。

【Note 1】 LKS-1903AN is set to needle thread clamp prohibited (no motion) with memory switch No. 35 at the time of standard delivery.

[3] 安裝

[3] INSTALLATION

1. 電氣箱的安裝

縫紉機機台上附屬的圓頭螺栓①平墊片②彈簧墊片③螺母④按照圖示的位置安裝好，再把頭上有六角凹坑的螺栓⑤彈簧墊⑥平墊片⑦按照圖示的位置安裝好。

1. Installing the electrical box

Install the electrical box on the underside of the table at the location illustrated using round-head bolt ① plain washer ②, spring washer ③ and nut ④ supplied with the machine, and using bolt having hexagonal indentation on the head ⑤, spring washer ⑥ and plain washer ⑦ supplied with the machine.

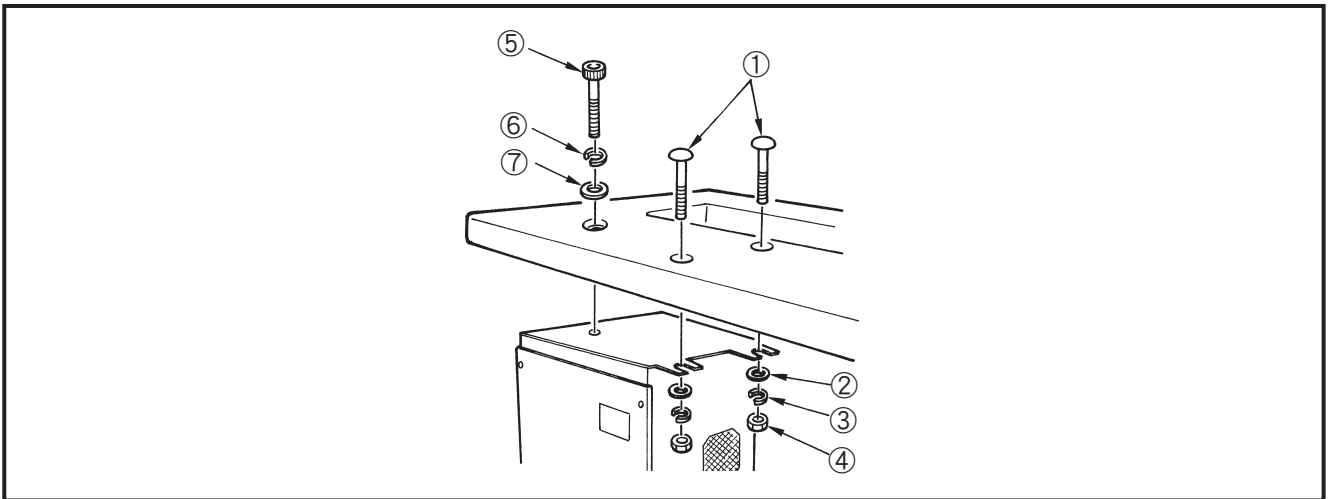

2. 連結桿的安裝方法

- (1) 把連結桿①用螺母③固定到踏板撥桿②的安裝孔B裡。
- (2) 把連結桿①安裝到安裝孔A之後，踏板的踩踏行程變大。

2. Attaching the connecting rod

- (1) Fix connecting rod ① to installing hole B of pedal lever ② with nut ③.
- (2) when connecting rod ① is installed in installing hole A, the depressing stroke of the pedal is increased.

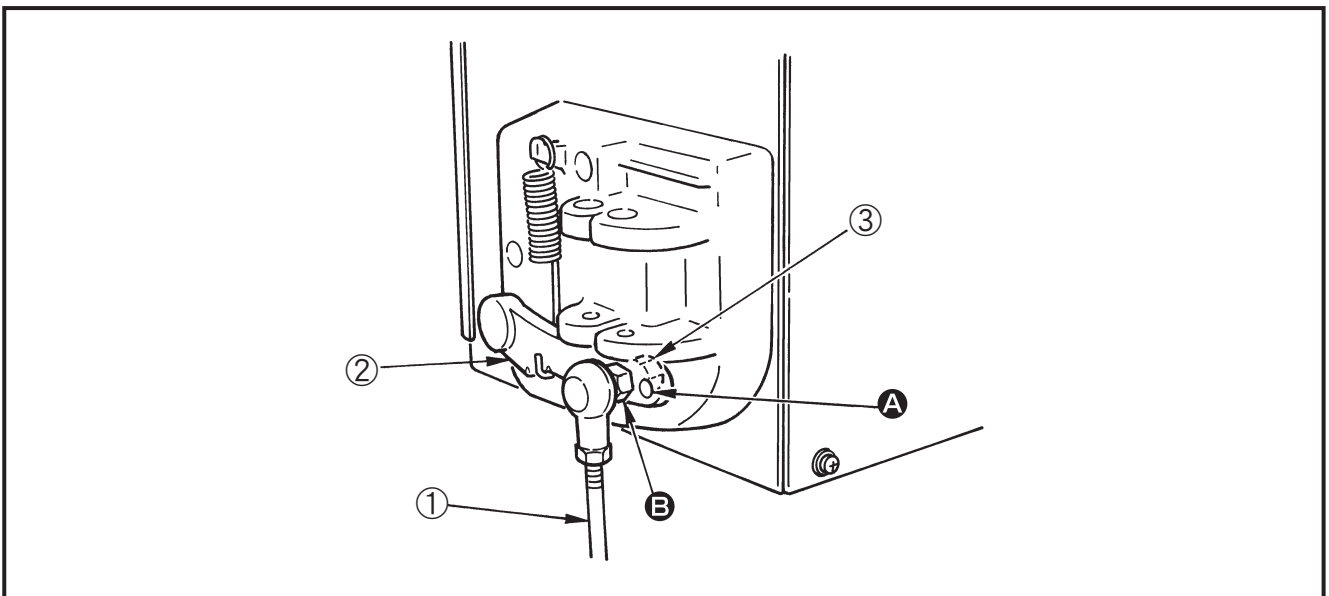

3. 機頭部支桿的安裝
把機頭部支桿①插到機台孔②裡。

3. Installing the head support rod
Drive head support rod ① in hole ② in the machine table.

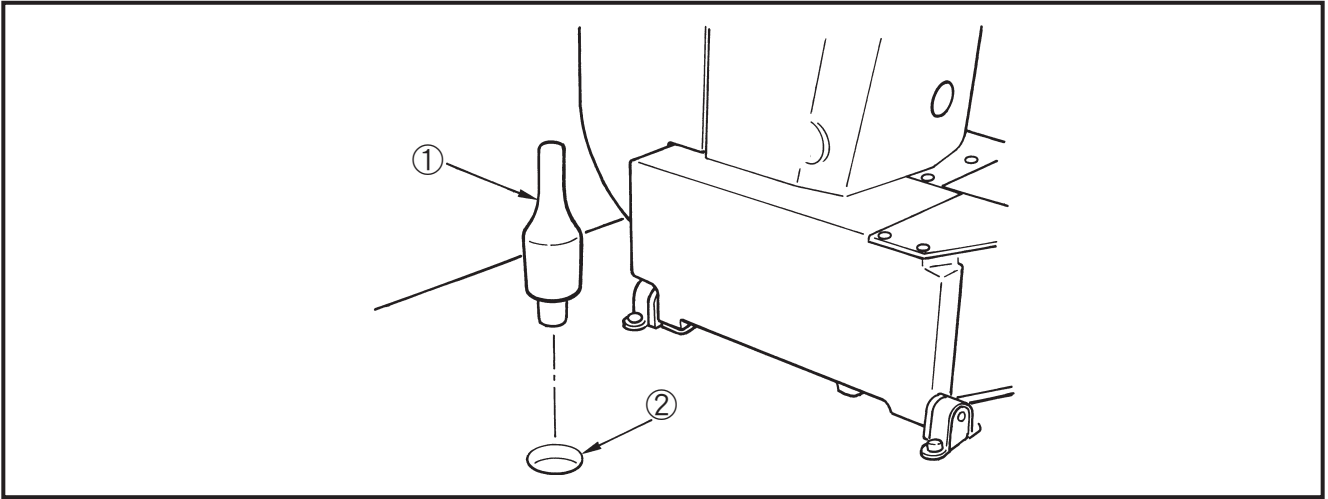

4. 電源開關的安裝、連接
(1) 電源開關的安裝
請把電源開關①用木螺絲②固定到機台下面。請根據使用狀態，用附屬的卡扣③固定好電纜線。

4. Installing and connecting the power switch
(1) Installing the power switch
Fix power switch ① under the machine table with wood screws ②. Fix the cable with staples ③ supplied with the machine as accessories in accordance with the forms of use.

※ 卡扣③包括固定操作盤電纜用共附屬了 5 個。

※ Five staples ③ including the staple for fixing the operation panel cable are supplied as accessories.

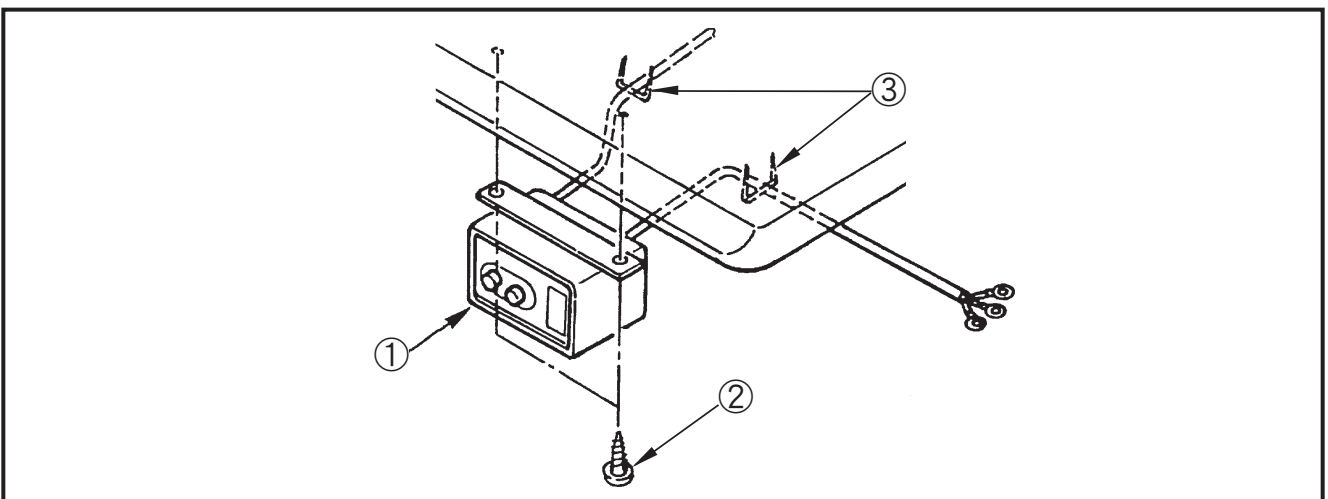

(2) 電源線的連接

在電壓表示標籤上寫有電源規格。請根據規格選擇電線。

(2) Connecting the power source cord
Voltage specifications at the time of delivery from the factory are indicated on the voltage indication seal. Connect the cord in accordance with the specifications.

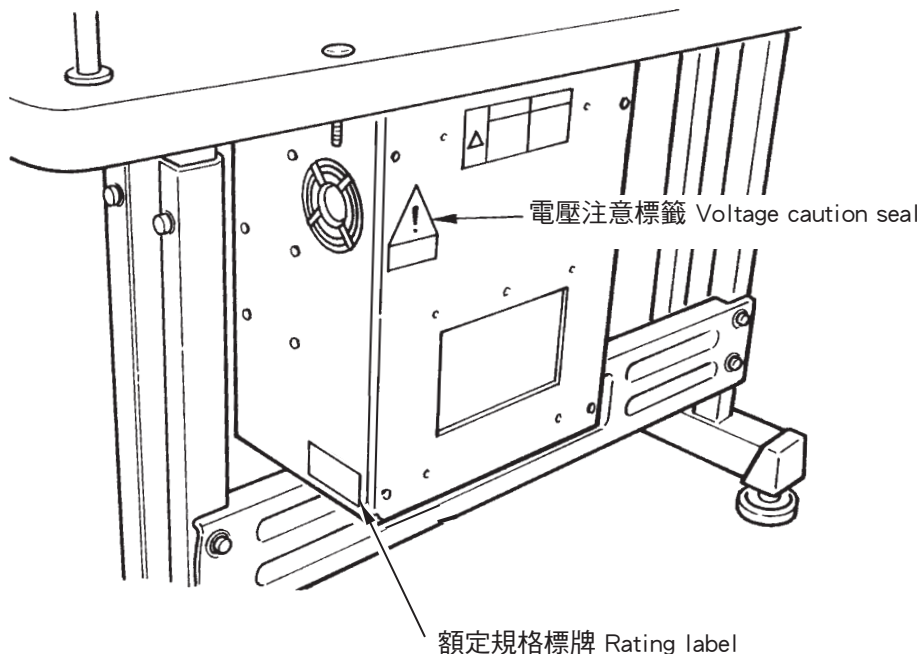

- 單相 200V、220V、230V 和 240V 的連接
Connecting single phase 200V, 220V, 230V and 240V

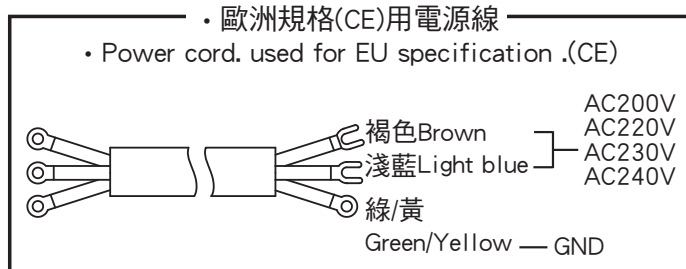
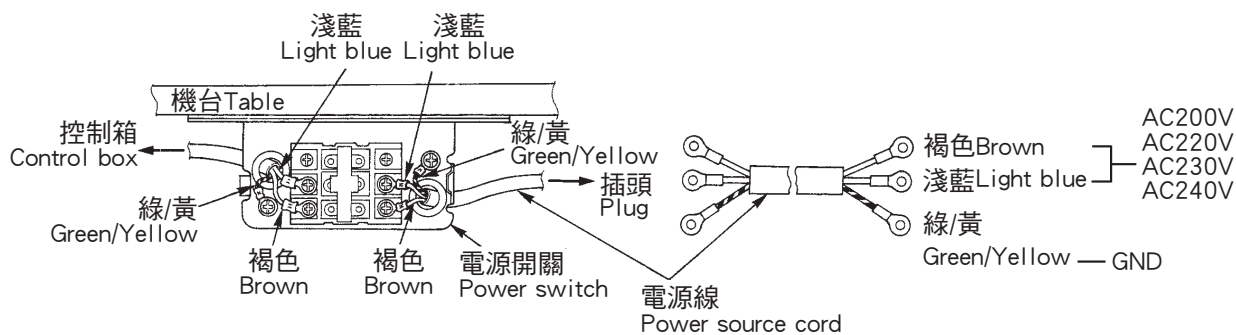

注意：在電壓規格不同的狀態下絕對不能使用。

Caution: Never use under the wrong voltage and phase.

5. 縫紉機的搬運方法
搬運縫紉機時，請如圖所示那樣。

5. How to carry the sewing machine
To carry the sewing machine please refer to the picture as below.

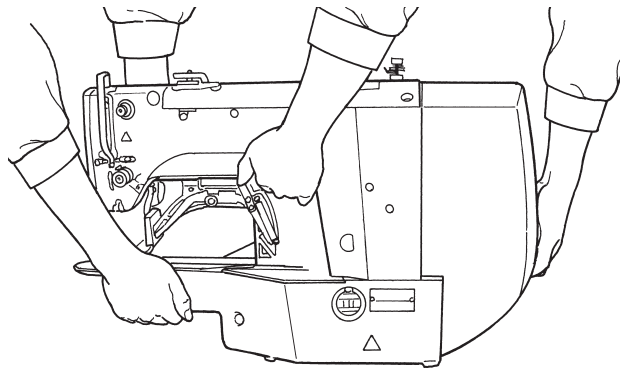

注意：1. 請注意不要讓拿著護罩的手發生滑動。

2. 縫紉機的重大達 42kg 以上，因此請一定用 2 個人以上來搬運。

Caution: 1. Carefully prevent slippage of your hand that holds the cover.

2. The sewing machine weighs over 42 kg. Be sure to carry the sewing machine with two or more people without exceptions.

6. 縫紉機機頭的安裝
(1) 把膠墊①插到機軸上，固定縫紉機主體。
(2) 鎖緊固定絞鏈橡膠①的螺母③時，請鎖緊螺母③讓彈簧墊②成為圖中 B 所示的那樣，然後用螺母④進行固定。

6. Installation of the sewing machine head
(1) Fit hinge rubber ① to the hinge shaft, and fix the sewing machine main unit.
(2) When tightening nut ③ to hinge rubber ①, tighten nut ③ until spring washer ② becomes as B in the illustration, and fix it with nut ④.



警告
WARNING

搬運縫紉機時，請一定 2 人以上進行搬運。

To prevent possible accidents caused by the full of the sewing machine, perform the work by two persons or more when the machine is moved.

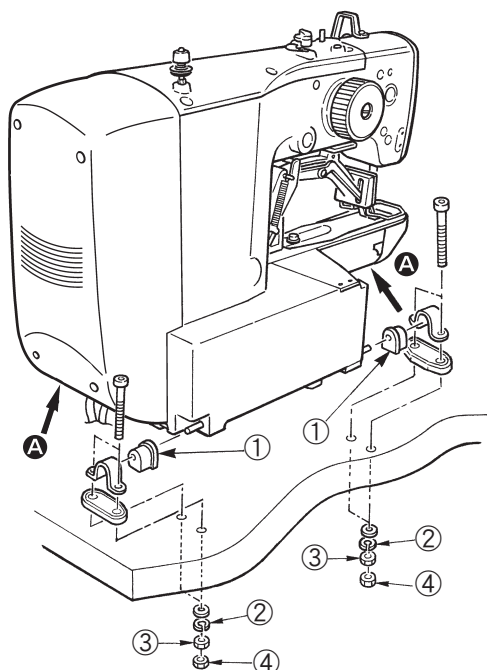

注意：1. 絞鏈橡膠①鎖得過緊的話，就會妨礙其功能的正常發揮，務請注意。

2. 搬運縫紉機時，請手持 A 部，並用手托住縫紉機的側面。

Caution: 1. If tightening hinge rubber ① excessively, it will not work properly. So, be careful.
2. When carrying the sewing machine, hold sections A with hands to support the side faces of the sewing machine.

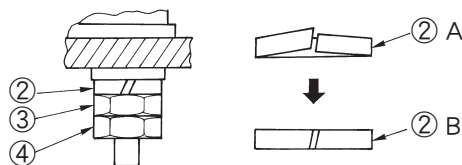

7. 廢油槽和機頭支撐橡膠的安裝

- (1) 用固定螺絲③（2 個）把廢油槽②固定到機台①的安裝孔上。
- (2) 把廢油銷④鎖進廢油槽②。
- (3) 把縫紉機廢油管⑤插到廢油銷④裡
- (4) 把機頭支撐橡膠⑥插進機台①。

7. Installing the drain receiver and the head support rubber

- (1) Fix drain receiver ② to the installing hole of table ① with two setscrews ③ .
- (2) Screw in drain bin ④ to drain receiver ② .
- (3) Insert sewing machine drain pipe ⑤ into drain bin ④ .
- (4) Insert head support rubber ⑥ into table ① .

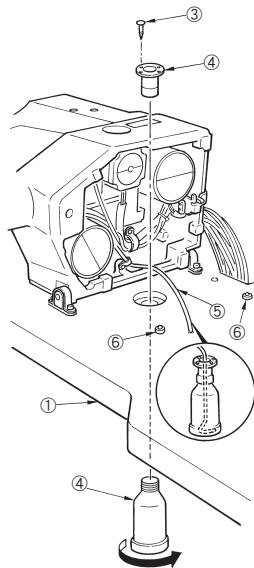

注意 : 1. 放倒縫紉機機頭後，廢油管⑤應該不從廢油銷④脫落，牢牢地插到最裡面。

2. 請卸下固定廢油管⑤的膠帶。

Caution: 1. Insert drain pipe ⑤ until it will go no further so that it does not come off drain bin ④ when tilting the machine head.

2. Remove the tape which was used to fix the drain pipe ⑤ .

8. 安全開關

請取下固定安全開關②的撥桿部的膠帶①。

8. Safety switch

Remove tape ① fixing the lever section of safety switch ② .

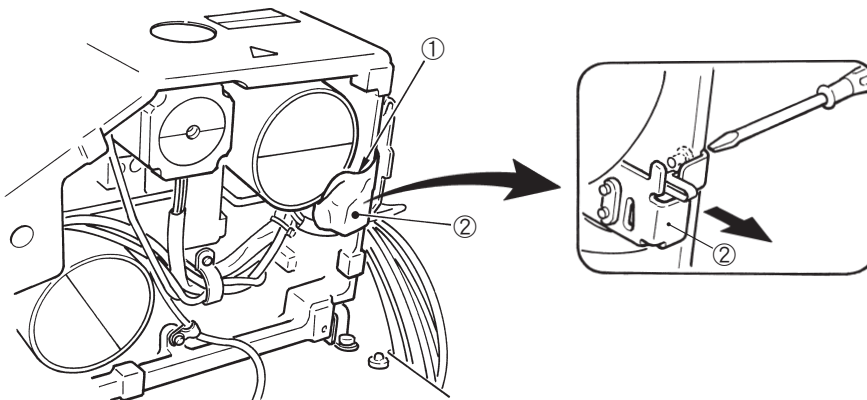

注意 : 1. 不取下膠帶①使用的話，放倒縫紉機的狀態下縫紉機也會轉動，非常危險。

2. 安裝後，縫紉機動作時如果發生異常 302，請用螺絲起子放鬆安全開關安裝的下方調整安全開關②的位置。

Caution: 1. It's very dangerous to use the safety switch without removing tape since the sewing machine works even in the state that it is tilted.

2. In case error 302 occurs when the sewing machine works after installation, loosen the safety switch fitting screw with a screwdriver, and lower the switch to the downside of the sewing machine.

9. 縫紉機的放倒方法

放倒縫紉機時，請輕輕地放，把縫紉機放在機頭支桿①上。

9. Tilting the sewing machine head

When tilting the sewing machine head, tilt the head gently until it touches the head support rod ① .



警告
WARNING

放倒縫紉機和抬起縫紉機時，請注意不要讓縫紉機夾住手指。同時，為了防止突然的起動發生意外的事故，請把電源關掉之後再進行操作。

To tilt/raise the sewing machine head with both hands taking care not to allow your fingers to be caught in the head. Turn OFF the power first to prevent accidents caused by abrupt start of the sewing machine.

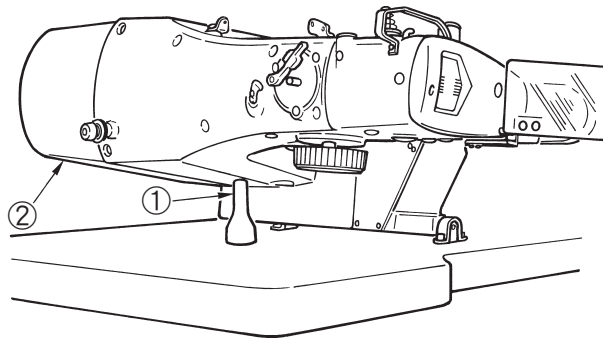

注意：1. 放倒縫紉機前，請先確認機台上是否安裝有機頭支桿①。

2. 抬起縫紉機時，請不要搬馬達外罩②來抬起縫紉機，以免防止馬達外罩②損壞。

3. 為了防止機器翻倒，請一定在平坦的地方放倒縫紉機。

Caution: 1. Before tilting the sewing machine head, make sure that head support rod ① is attached to the machine table.

2. When raising the sewing machine head, do not raise it while holding motor cover ② . It will be the cause of breakage of motor cover ② .

3. Be sure to tilt the sewing machine head on a flat place to prevent it from falling.

10. 操作盤的安裝

(1)用木螺絲②把操作盤安裝板①固定到機台上，把電纜線穿過機台孔④。用附屬的螺絲③把操作盤固定到操作盤安裝板①上。請把電纜線用附屬的卡扣固定到機台背面。

10. Installing the operation panel

(1) Fix operation panel installing plate ① on the machine table with wood screws ② and pass the cable through hole ④ in the machine table. Fix the operation panel on panel installing plate ① with screws ③ supplied as accessories. Fix the cable on the bottom surface of the table with the staples supplied with the machine as accessories.

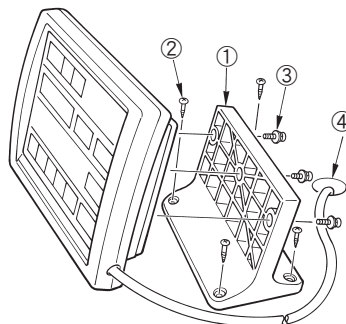

(2)在機台下面安裝操作盤時請參照下圖進行安裝。

(2)Refer to the figure on the below side when installing the panel under the table.

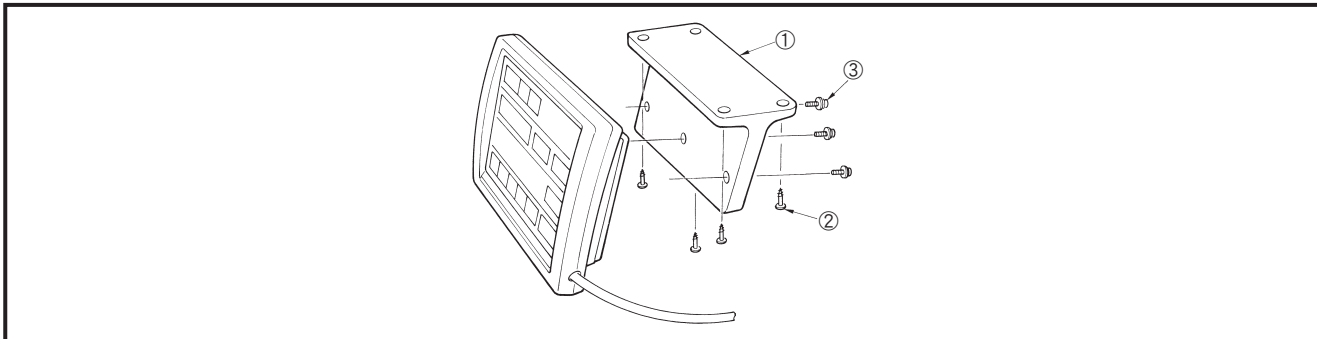

11. 電纜線的連接

(1)卸下 4 根固定電氣箱裡蓋的螺絲①。打開裡蓋時，如圖所示用手一邊按壓一邊打開約 90° 不動為止。

11. Connecting the cord

(1)Remove four screws ① fixing the rear cover of the electrical box. When opening the rear cover, pressing it with your hands, slowly open it by approximately 90° until it stops as illustrated.

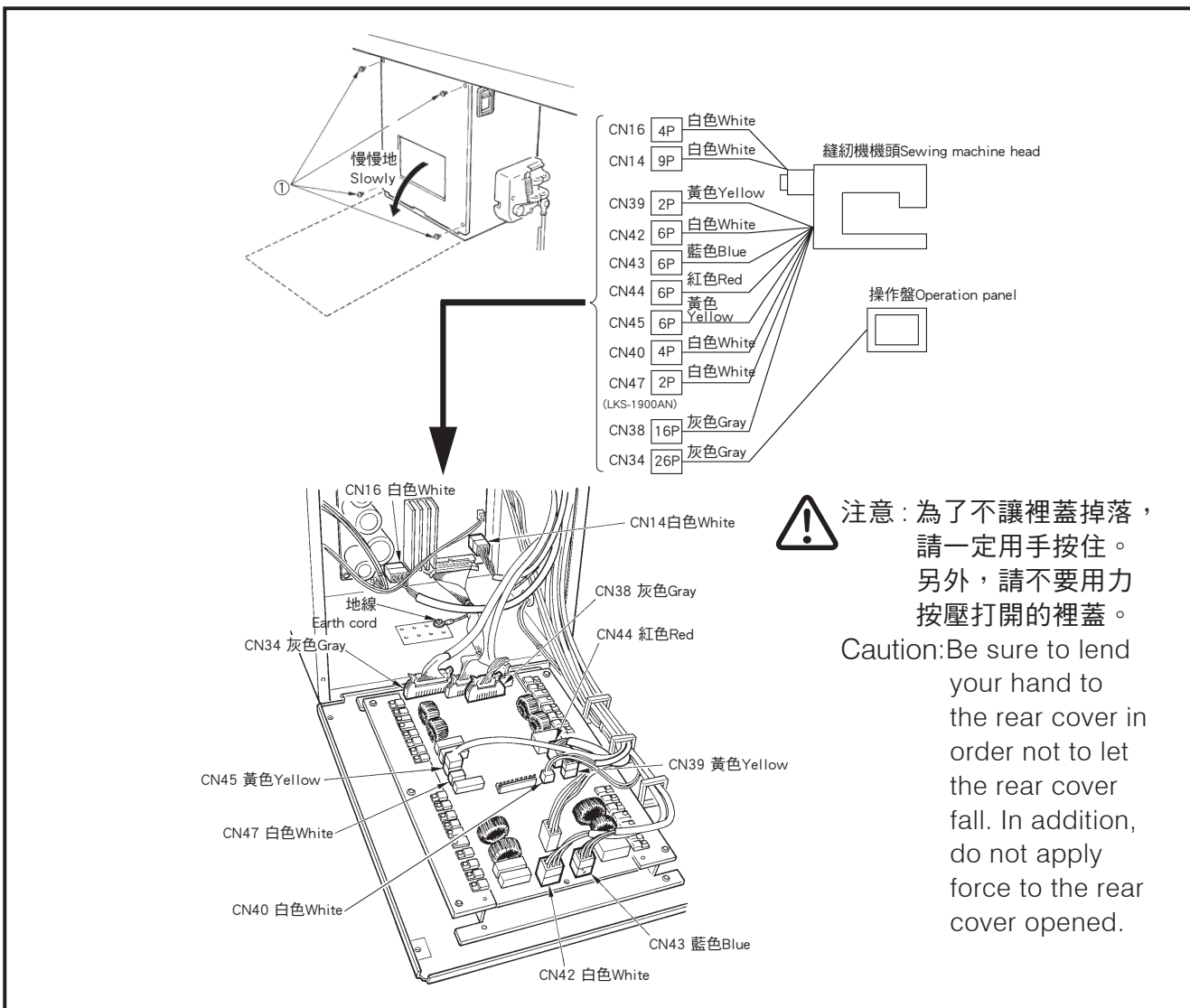

- (2) 請充分注意不要讓裡蓋和電氣箱體把線咬壞，按住裡蓋下側 A 部關閉，再鎖緊 4 根螺絲①。
- (3) 向下降低按壓電氣箱旁邊的電纜線和按孔 B 的電纜線壓板 C，按壓電纜線，鎖緊螺絲②。

- (2) Take care so that the cord is not caught between the rear cover and the electrical box main body, close the rear cover while pressing section A on the lower side of the rear cover, and tighten four screws ①.
- (3) Lower downward the cord located on the side of the control box and cord presser plate C in the push hole B, press the cord and tighten screws ②.

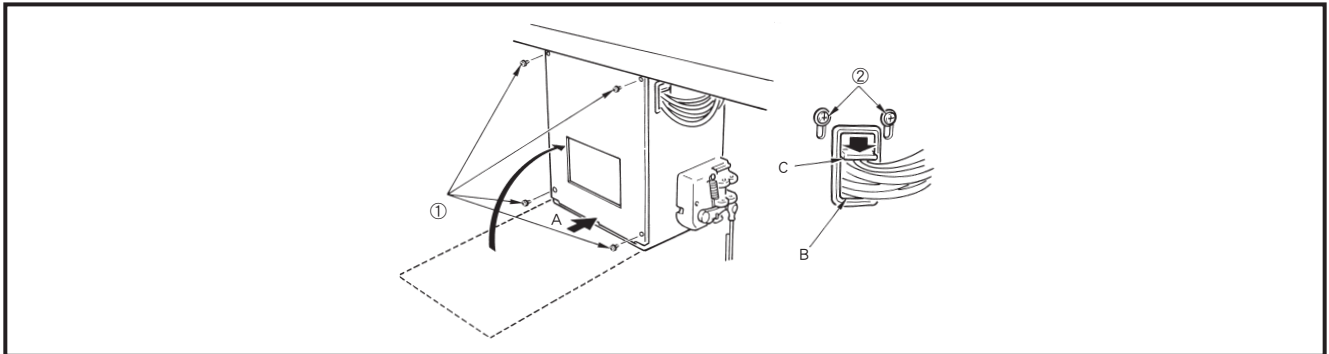

電纜夾的固定方法 How to lock the cord clamp

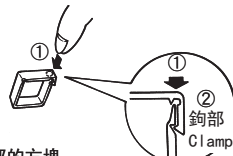

- ① 輕輕地按壓鉤部的方塊。
(聽到喀嗒的聲音就固定好了。)
- ① Lightly press the corner of clamp.
(Cord clamp is locked with a click.)

電纜夾的解開方法 How to remove the cord clamp

- ① 一邊輕輕地按住。 ① Lightly pressing.
② 一邊下拉電纜夾。 ② Pull down the clamp.
③ 再向上提電纜夾。 ③ The clamp goes up.

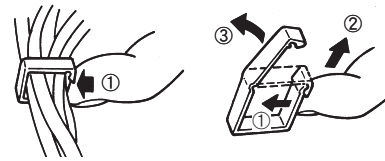

12. 電線的處理

- (1) 在放倒縫紉機的狀態，連接電線，如圖所示用線束夾①捆緊。
- (2) 如圖所示，讓電線稍稍彎垂，用電線固定板②固定電線。

12. Managing the cord

- (1) In the state that the sewing machine is tilted, connecting the cords, and bundle them with clip band ① as shown in the figure.
- (2) Fix the cords with cords setting plate ② in the state that the cords slacken as shown in the figure.

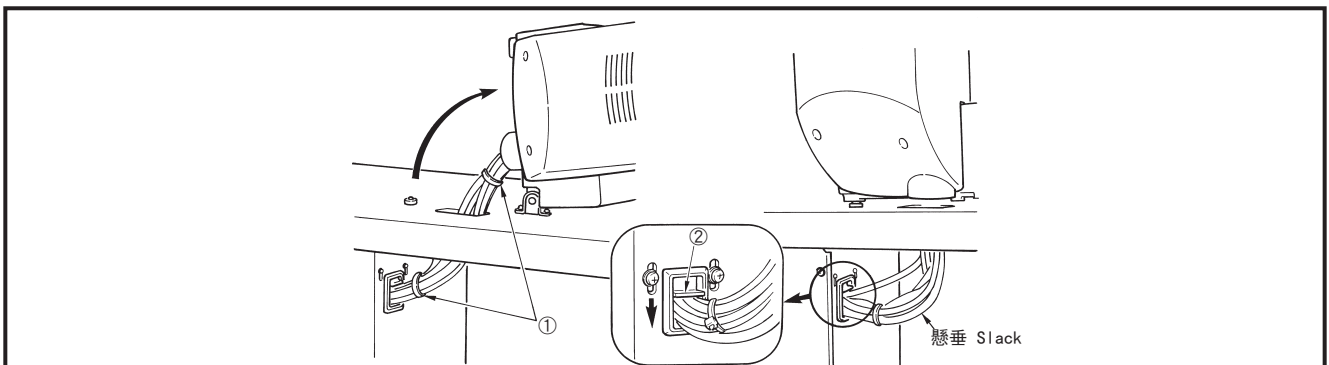

注意：放倒縫紉機時，請確認機頭支桿安裝在機臺上。

Caution: When you tilt the sewing machine, make sure that the sewing machine head support bar is placed on the table.

13. 護目鏡的安裝

請一定把護目鏡①用螺絲②安裝到安裝部③之後再使用縫紉機。

13. Installing the eye protection cover

Be sure to use eye protection cover ① after installing it on installing section ③ with screws ② .



危險
WARNING

為了保護斷針飛起弄傷眼睛，請一定安裝起來。

Be sure to attach this cover to protect the eyes from the disperse of needle breakage.

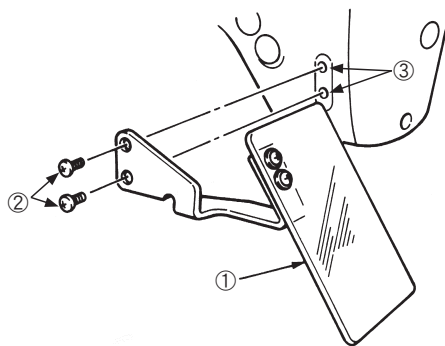

14. 線架的安裝

(1)如圖所示那樣把線架安裝到機台孔上。
(2)用固定螺母①固定線架。
(3)頂線配線時，請把電源線從線架桿②中穿過。

14. Installing the thread stand

(1)Assemble the thread stand unit, and insert it in to the hole on the machine table.
(2)Tighten locknut ① to fix the thread stand.
(3)For ceiling wiring, pass the power cord through spool rest rod ② .

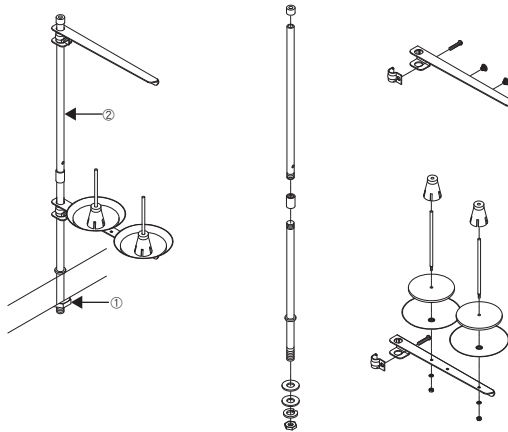

[4] 縫紉機的準備

[4] OPERATION OF THE SEWING MACHINE

1. 加油方法

請確認機油在下線 B 和上線 A 之間。如果機油過少時，請用附屬的加油器進行加油。

1. Lubrication

Check that the place between lower line B and upper line A is filled with oil. Fill there with oil using the oiler supplied with the machine as accessories when oil is short.

※ 加油的油槽僅是向旋梭加油的。使用低轉速時，如果旋梭的油量過多，可以把油量調小。（請參照「1.[7]-8. 旋梭的加油量」 P.46。）

※ The oil tank which is filled with oil is only for lubricating to the hook portion. It is possible to reduce the oil supply when the number of rotation used is low and the oil amount in the hook portion is excessive. (Refer to " 1.[7]-8. Amount of oil supplied to the hook" p.46)



警告
WARNING

為了防止突然的起動造成人身事故，請關掉電源後再進行操作。

Turn OFF the power before starting the work so as to prevent accidents caused by abrupt start of the sewing machine.

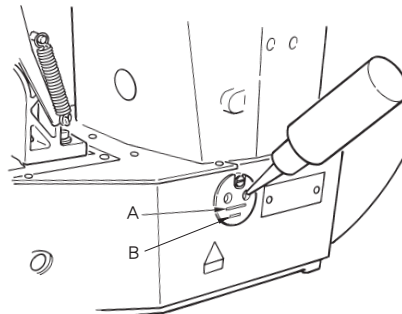

注意：1. 請注意不要向油槽和下列注意 2 的旋梭以外的部位加油。否則會發生零件故障。
2. 初次使用縫紉機或較長時間沒有使用縫紉機時，請向旋梭加少量的機油後再使用縫紉機。（請參照「1.[7]-2. 機針與旋梭」 P.40。）

Caution: 1. Do not lubricate to the places other than the oil tank and the hook of Caution 2 below. Trouble of components will be caused.

2. When using the sewing machine for the first time or after an extended period of disuse, use the machine after lubricating a small amount of oil to the hook portion. (Refer to " 1.[7]-2.Adjusting the needle-to-shuttle relation" p.40.)

2. 機針的安裝方法

安裝機針時，請放鬆固定螺絲①，把機針②的長溝③朝向面前，插進針桿的深處，然後鎖緊固定螺絲①。

2. Attaching the needle

Loosen setscrew ① and hold needle ② with the long groove ③ facing toward you. Then fully insert it into the hole in the needle bar, and tighten setscrew ①.



警告
WARNING

為了防止突然的起動造成人身事故，請關掉電源後再進行操作。

Turn OFF the power before starting the work so as to prevent accidents caused by abrupt start of the sewing machine.

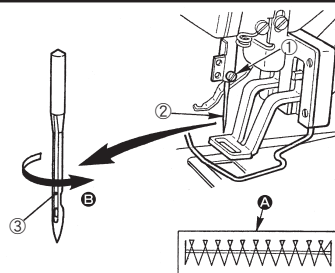

注意：縫跡如 A 時，請把機針向 B 方向稍稍移動然後安裝起來。

Caution: If the stitches are made as shown in A, attach the needle facing to the direction B to a small extent.

3. 上線的穿線方法

穿過機針的線應留出 40mm 左右。

3. Threading the machine head

Pull out the thread by approximately 40mm from the needle after threading through the needle.



警告
WARNING

為了防止突然的起動造成人身事故，請關掉電源後再進行操作。

Turn OFF the power before starting the work so as to prevent accidents caused by abrupt start of the sewing machine.

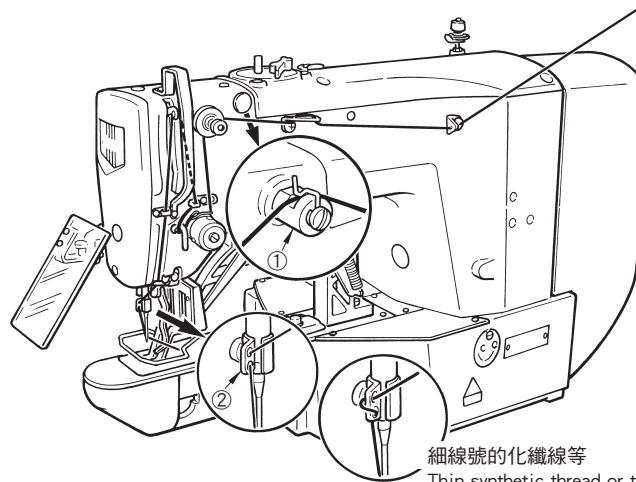

注意：1. 使用矽油時，請把線穿過潤滑導線器①。（選購品）

2. 粗線時，請把機線只穿過針桿導線器② 1 個孔。

Caution: 1. When the silicon oil is used, thread through thread guide for silicon

① (Optional)

2. For thick thread, pass the thread through one hole only of needle bar thread guide ② .

4. 梭殼的取下插入

(1) 打開旋梭外罩①。

(2) 撥起旋梭殼②的夾腳③，取出梭殼。

(3) 插入時，請把梭殼深深插入旋梭軸，並關閉夾腳。

4. Installing and removing the bobbin case

(1) Open hook cover ① .

(2) Raise latch ③ of bobbin case ② , and remove the bobbin case.

(3) When installing the bobbin case, fully insert it into the shuttle shaft, and close the latch.

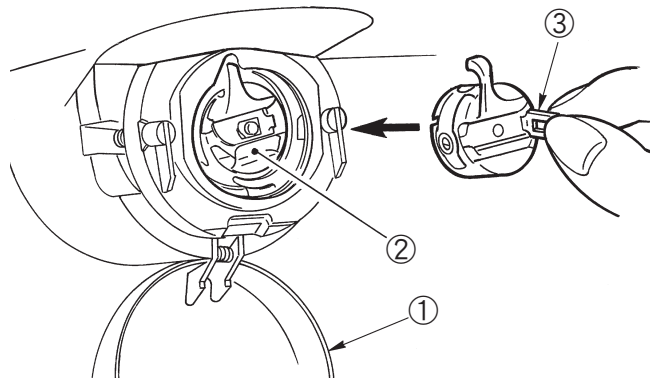

注意：如果沒有插到底，縫製途中梭殼②就有可能脫落。

Caution: If it is not fully inserted, bobbin case ② may slip off during sewing.

5. 旋梭的插入方法

- (1) 把旋梭①按圖示的方向插入梭殼②。
- (2) 把線穿過梭殼②的穿線口③，然後拉線，把線從線張力彈簧下面的穿線口④拉出來。
- (3) 把線從角部的線孔⑤穿出，從線孔約拉出25mm。

5. Installing the bobbin

- (1) Set the bobbin ① into bobbin case ② in the direction shown in the figure.
- (2) Pass the thread through thread slit ③ of bobbin case ②, and pull the thread as it is. By so doing, the thread will pass under the tension spring and be pulled out from thread hole ④.
- (3) Pass the thread through thread hole ⑤ of the horn section, and pull out the thread by 25mm from the thread hole.



警告
WARNING

為了防止突然的起動造成人身事故，請關掉電源後再進行操作。

Turn OFF the power before starting the work so as to prevent accidents caused by abrupt start of the sewing machine.

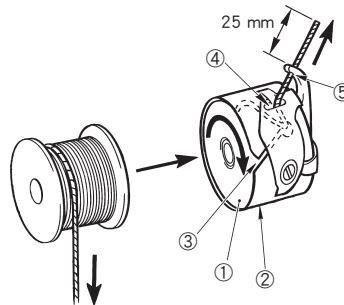

注意：旋梭的旋轉方向相反的話，底線的拉出就不穩定。

Caution: If the bobbin is installed in the bobbin case orienting the reverse direction, the bobbin thread pulling out will result in an inconsistent state.

6. 線張力的調整方法



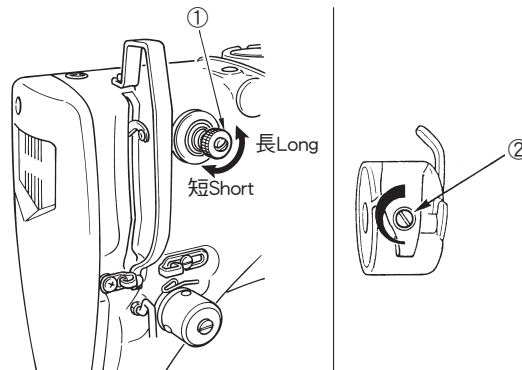

- (1) 把第一線張力旋鈕①向右轉動，切線後針尖上的殘線長度變短，向左轉動後變長。
- (2) 請盡量在不脫線的情況下弄短殘線。
- (3) 在操作盤上調整上線張力，用②調整底線張力。

6. Adjusting the thread tension





- (1) If thread tension controller No. 1 ① is turned clockwise, the length of remaining thread on the needle after thread trimming will be shorter. If it is turned counterclockwise, the length will be longer.
- (2) Shorten the length to an extent that the thread is not slipped off.
- (3) Adjust needle thread tension from the operation panel and bobbin thread tension with ②.



(4) 上線張力的調整

- 1) 按  鍵，選擇線張力 。
 - 2) 用  鍵、 鍵設定上線張力。設定範圍是 0 ~ 200。設定值越大，張力也越大。
- ※ 標準出貨時，被設定為設定值 50、1.5N（縫紉機線 #50）。（第 1 線張力盤開放時）

(4) Adjusting the needle thread tension

- 1) Select thread tension  with  key.
 - 2) Set needle thread tension with  key or  key. There is a setting range of 0 to 200. When the set value is increased, the tension becomes higher.
- ※ The tension is set so that 1.5 N (spun thread #50) is obtained at the set value 50 at the time of standard delivery. (When thread tension No.1 is released.)

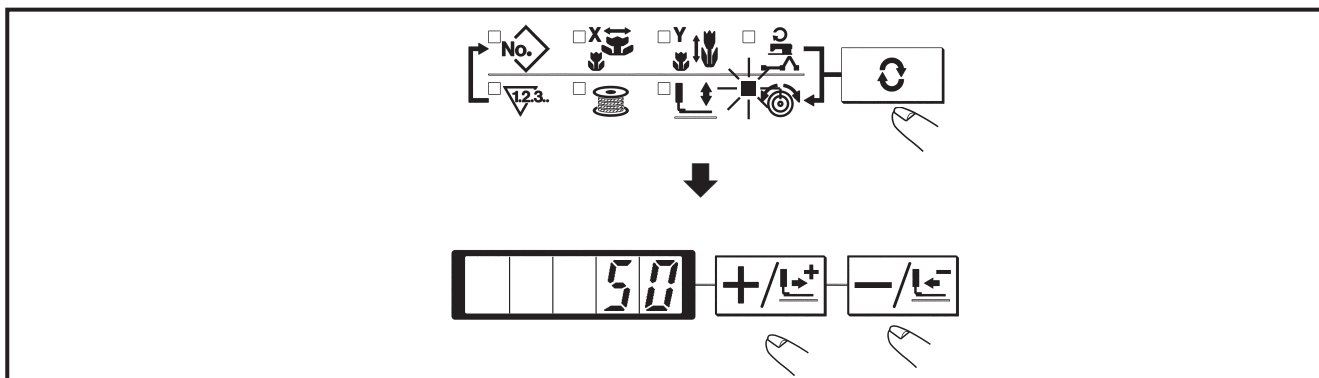

7. 挑線彈簧的調節

- 挑線彈簧①的標準移動量為 8 ~ 10mm，開始挑線時的強度為 0.1 ~ 0.3N。
- (1) 移動量的調節
放鬆固定螺絲②，轉動線張力結合體③。向右轉動之後，動作量變大，拉線量變多。
 - (2) 強度的調節
改變挑線彈簧的強度時，請在螺絲②鎖緊的狀態下，把細螺絲刀插到線張力桿④的缺口部轉動調節。向右轉動之後，挑線彈簧的強度變強，向左轉動之後，強度變弱。

7. Adjusting the thread take-up spring

- The standard stroke of thread take-up spring ① is 8 to 10 mm, and the pressure at the start is 0.1 to 0.3N.
- (1) Adjusting the stroke
Loosen setscrew ②, and turn thread tension asm ③. Turning it clockwise will increase the moving amount and the thread drawing amount will increase.
 - (2) Adjusting the pressure
To change the pressure of the thread take-up spring, insert a thin screwdriver into the slot of thread tension post ④ while screw ② is tightened, and turn it. Turning it clockwise will increase the pressure of the thread take-up spring. Turning it counterclockwise will decrease the pressure.

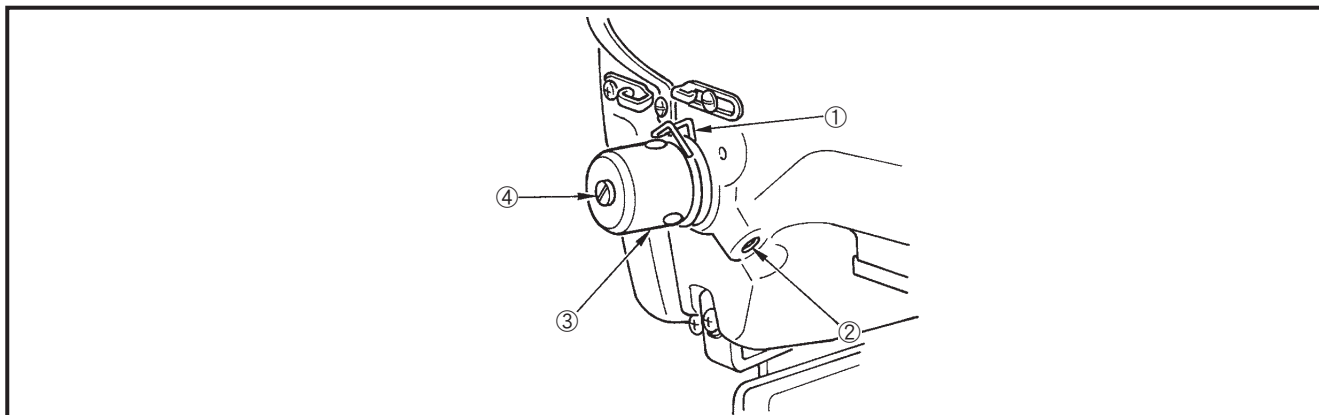

8. 縫製張力

- 初次使用時，請參考下表調整縫製張力。

8. Example of the thread tension

- When using the sewing machine for the first time, adjust the thread tension referring to the table below.

機線 Thread	布料 Material	設定上線張力 Needle thread tension setting	挑線彈簧的動作量 [拉線量] Thread take-up spring moving amount [Thread drawing amount]	強度 Strength
聚酯長纖維線 #50 Polyester filament thread #50	毛 Wool	30 ~ 35	10mm [13mm]	0.1N
聚酯短纖維線 #50 Polyester spun thread #50	毛 Wool	50 ~ 55	10mm [13mm]	0.2N
聚酯短纖維線 #60 (夾線 OFF) Polyester spun thread #60 (Thread clamp OFF)	T/C 寬頻 T/C broad	30 ~ 35	8 ~ 10mm [11 ~ 13mm]	0.1N
棉線 #50 Cotton thread #50	牛仔布 Denim	35 ~ 45	10mm [13mm]	0.1N
棉線 #20 Cotton thread #20	牛仔布 Denim	35 ~ 45	8 ~ 10mm [11 ~ 13mm]	0.1N

[5] 縫紉機的操作（基礎篇）

[5] OPERATION OF THE SEWING MACHINE (BASIC)

1. 項目數據的設定

請按如下的順序設定各項目。

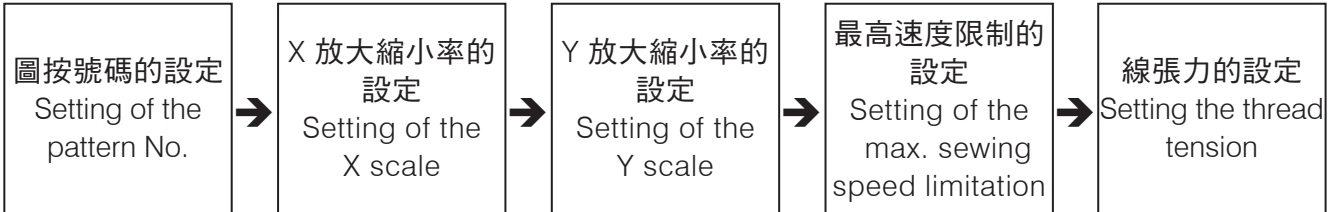

(1) 打開電源開關

項目選擇的圖案號碼亮燈，資料顯示部顯示出圖案號碼。

(2) 圖案號碼的設定

- 1) 按 鍵，設定為圖案 No. 號碼的項目顯示。
- 2) 按 、 鍵，畫面上顯示出 14。（設定為 No.14 圖案）

1. Item data setting

Set each item following the procedure described below.

(1) Turn ON the power switch.

Pattern No. of the item selection lights up, and the pattern No. is indicated on the data display.

(2) Setting of the pattern No.

- 1) Press the key to indicate the item "Pattern NO" .
- 2) Press the or key to indicate "14" on the display. (Pattern No. is set to 14.)

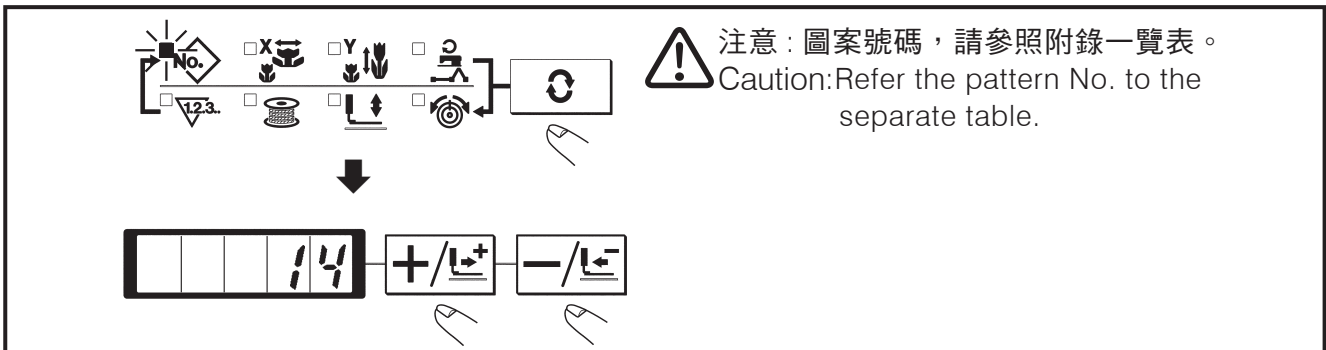

(3) X 放大縮小率的設定



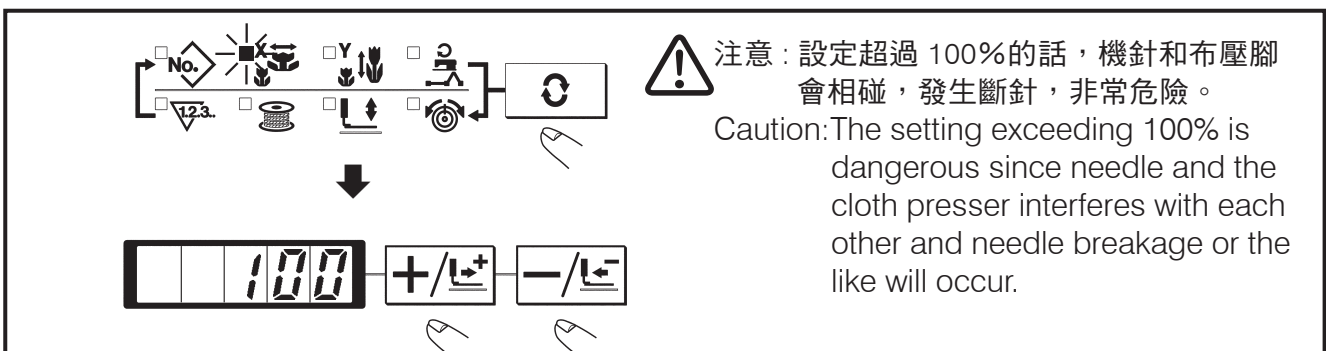

- 1) 按 鍵，設定為「X 放大縮小率」 的專案顯示。
- 2) 按 、 鍵，讓縫紉機顯示出「100」。（把 X 擴大縮小率設定為 100%）

(3) Setting of the X scale





- 1) Press the key to indicate the item "X Scale" .
- 2) Press the or key to indicate "100". (Set X scale to 100%.)



(4) Y 放大縮小率的設定





- 1) 按  鍵，設定為「Y 放大縮小率」 的專案顯示。
- 2) 按 、 鍵，讓縫紉機顯示出「100」。(把 Y 擴大縮小率設定為 100%)

(4) Setting of the Y scale





- 1) Press the  key to indicate the item “Y Scale” .
- 2) Press the  or  key to indicate “100”. (Set Y scale to 100%.)



(5) 最高轉速限制的設定



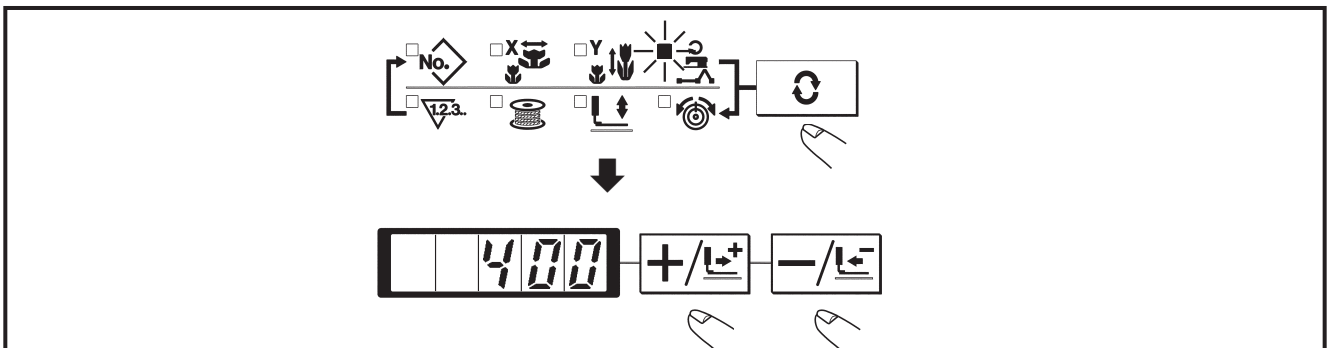

- 1) 按  鍵，設定為「轉速」 的專案顯示。
- 2) 按 、 鍵，讓縫紉機顯示出「400」。(設定為 400sti/min)

(5) Setting of the max. sewing speed limitation





- 1) Press the  key to indicate the item “Speed” .
- 2) Press  or  key to indicate “400”. (Setting of 400 sti/min)



(6) 線張力的設定

- 1) 按  鍵，設定為「線張力」 的顯示項目。
- 2) 按 、 鍵，讓縫紉機顯示出「50」。(可以在 0 ~ 200 的範圍進行設定)

(6) Setting the thread tension

- 1) Press  key to indicate the item “THREAD TENSION” .
- 2) Press  or  key to indicate “50”. (0 to 200 can be set.)

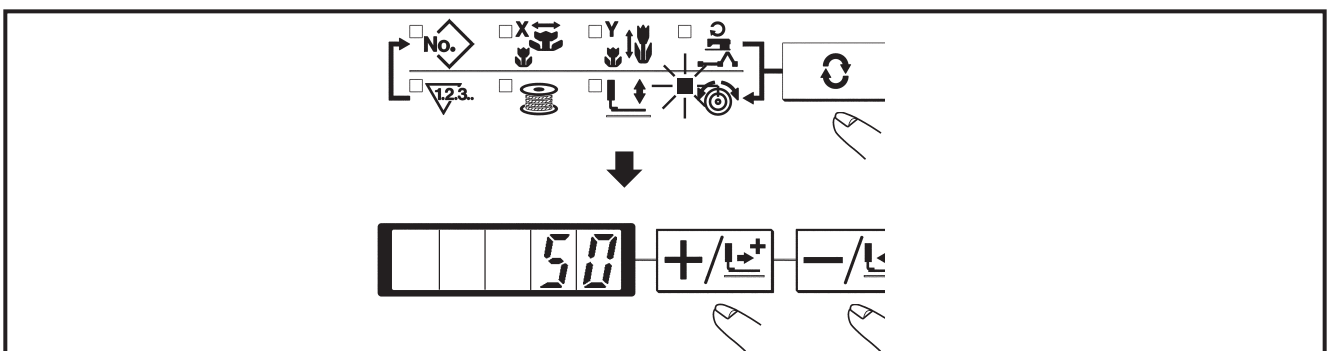





(7)設定結束

- 1) 按  鍵。
- 2) 壓腳移動→上升後，縫製 LED 亮燈，成為可以縫製的狀態。

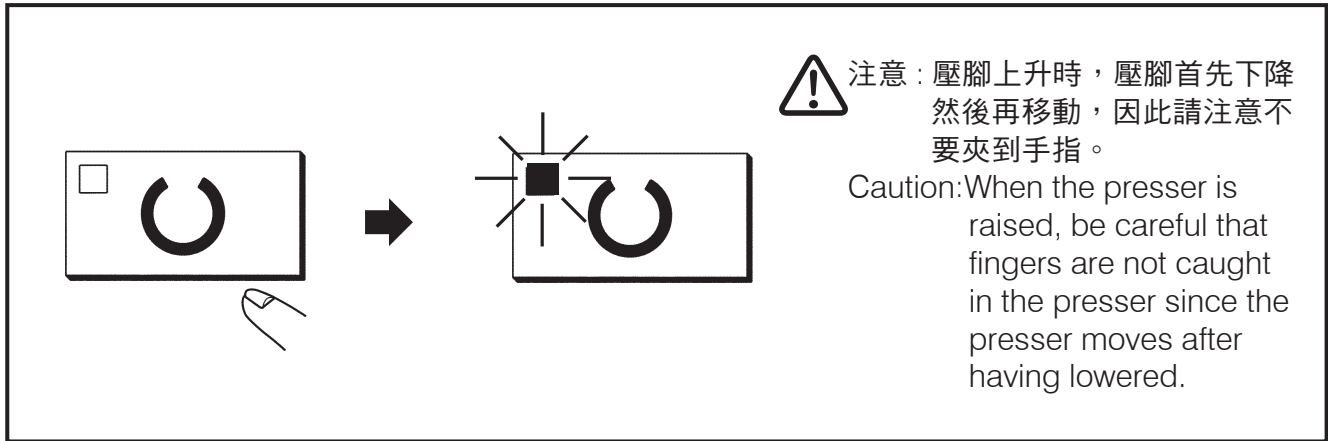



(7) Finish of setting

- 1) Press the  key.
- 2) After the work clamp feet have moved and gone up, the sewing LED lights up, and the sewing is ready.



- * 按  鍵之後，圖案 No.、XY 擴大縮小率等設定值被記憶。
- * 按  鍵之後，可以重新確認各設定項目，但是縫製 LED 亮燈的狀態不能變更。
- * 按  鍵之後，準備 LED 滅燈。各項目的設定值可以變更。
- * 線張力在縫製 LED 亮燈時也可以變更。線張力用開始 SW 也可以記憶。
- * 確認了圖案 No. 之後再使用。在圖案 No.0 顯示（出貨狀態）按  鍵之後，會顯示異常 E-10。此時，請重新設定圖案 No.。

★重要：不按  開關，關掉電源後，圖案 No.、XY 擴大縮小率、最高轉速、線張力的設定值均不能被記憶。

- * When  key was pressed, the set values of pattern No., X/Y scale, etc. are memorized.
- * If  key was pressed, you can make sure of the respective setting items again. However, the items can not be changed in the state that the SEWING LED is lit up.
- * When  key was pressed, the READY LED goes off. Set values of the respective items can be changed.
- * Thread tension can be changed even when the sewing LED lights up. Thread tension can be memorized with the start switch as well.
- * Use the machine after confirming the pattern No. When  key is pressed while pattern No. is indicated "0" (state at the time of delivery), error display E-10 appears. At this time, reset the pattern No.

★ Important: When turning OFF the power without pressing  key, the set values of pattern No., X/Y scale, number of max. rotation, and thread tension are not memorized.

- 注意：使用縱方向最大長度 (+ 10mm) 的圖案時，請確認送布台②和挑線桿座①的間隙。沒有間隙的話，請放鬆固定螺絲③把挑線桿向針側移動。特別是機針移動到右側裡面時，間隙應變小。

- Caution: When using a sewing pattern which is full in lengthwise direction (+10 mm), make sure of the clearance between cloth feed base ② and wiper base ①. If there is no clearance, loosen setscrew ③ and move the wiper to the needle side. Especially when the needle position comes to the rear on the right side, the clearance is decreased.

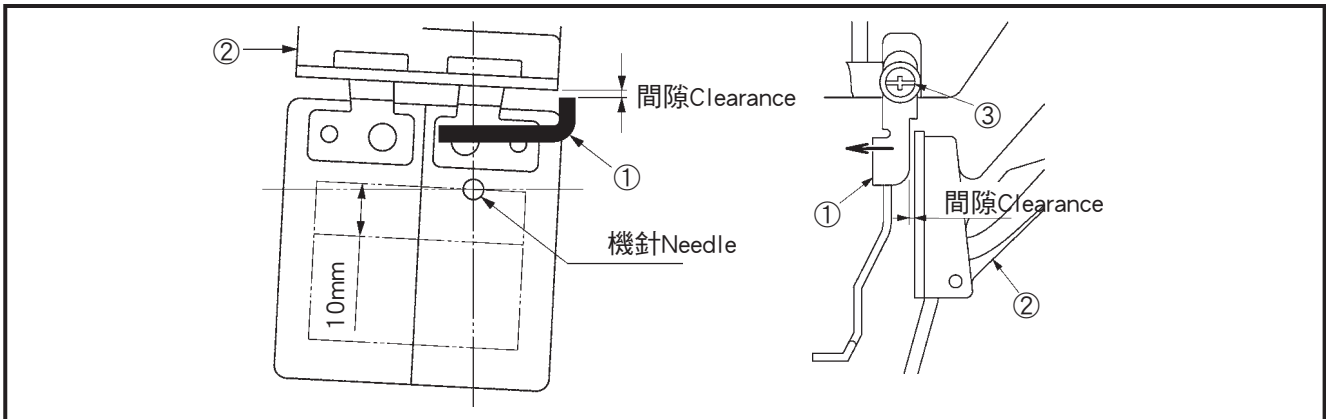

3. 縫製





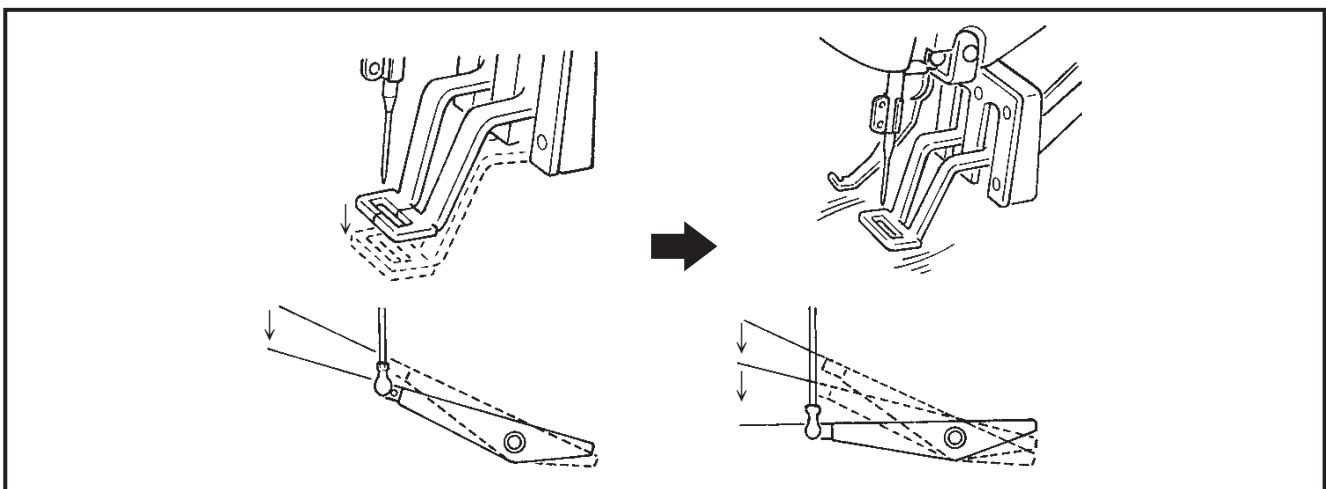

- (1) 把縫製品放到壓腳部。
- (2) 把踏板開關踩到第一級，壓腳下降，腳離開踏板後，壓腳上升。
- (3) 把壓腳下降一級，踩到第二級之後開始縫製。
- (4) 縫製結束後，壓腳上升返回到始縫的位置。

3. Sewing







- (1) Set a workpiece on the work clamp foot section.
- (2) Depress the pedal switch to the first step, and the work clamp feet will come down. If you detach your foot from the pedal switch, the work clamp feet will go up.
- (3) Depress the pedal switch to the second step after descending the work clamp feet at the first step, and the sewing machine will start sewing.
- (4) After the sewing machine completes sewing, the work clamp feet will go up, and return to the sewing start position.



4. 變更為其他圖案

- (1) 按  鍵，縫製 LED 滅燈。
- (2) 按  鍵，選擇圖案 No.  的項目。
- (3) 用 、 鍵設定圖案 No.。
- (4) 同樣地設定 XY 擴大縮小率、轉速等。
- (5) 按  鍵之後，縫製 LED 亮燈，成為可以縫製的狀態。

4. Change to the other sewing pattern

- (1) Make the Sewing LED go off with  key.
- (2) Press  key and select the item of pattern No. .
- (3) Set the pattern No. with  key or  key.
- (4) Similarly, setting of X/Y scale, speed, etc. is performed.
- (5) When  key is pressed, the Sewing LED lights up and the sewing machine is in the sewing ready state.



警告 WARNING

選擇圖案後，請一定確認圖案的形狀。

萬一圖案遠離壓腳，縫製途中機針會碰到壓腳，弄斷機針。

Make sure without fail of the contour of the sewing pattern after selection of the sewing pattern.

If the sewing pattern extends outside the work clamp feet, the needle will interfere with the work clamp feet during sewing, causing dangerous troubles including needle breakage.

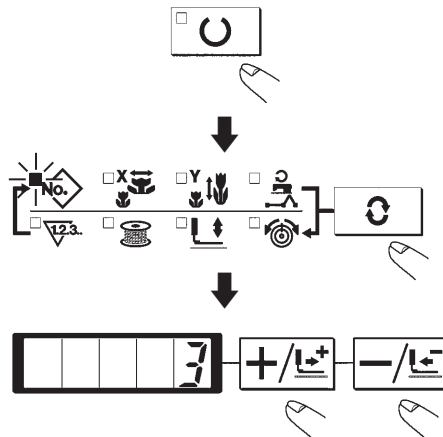

5. 捲繞底線







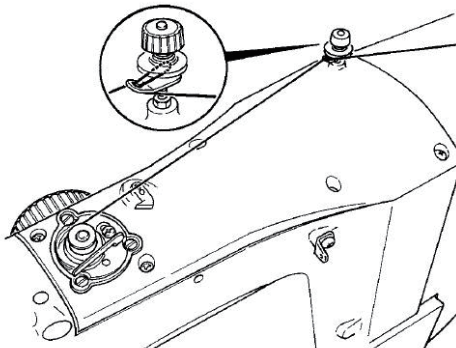

- (1) 邊縫製邊捲繞底線時：如圖所示穿線捲繞底線。

5. Winding a bobbin









- (1) To wind a bobbin while the sewing machine is performing sewing: Thread the bobbin winder and wind the bobbin thread onto the bobbin as illustrated in the figure.





(2) 光捲繞底線時

- 1) 按  鍵，讓縫製 LED 滅燈。
- 2) 按  鍵，選擇卷線 。
- ※ 注意：如果縫製 LED 亮燈時不能選擇。
- 3) 按  鍵。壓腳下降，縫製 LED 亮燈。
- 4) 踩踏踏板開關之後，縫紉機開始轉動。
- 5) 再次踩踏板，或者按  鍵、 鍵之後縫紉機停止轉動。
- 6) 按  鍵之後，縫製 LED 滅燈，壓腳上升， 鍵變為有效。

(2) To wind a bobbin independently

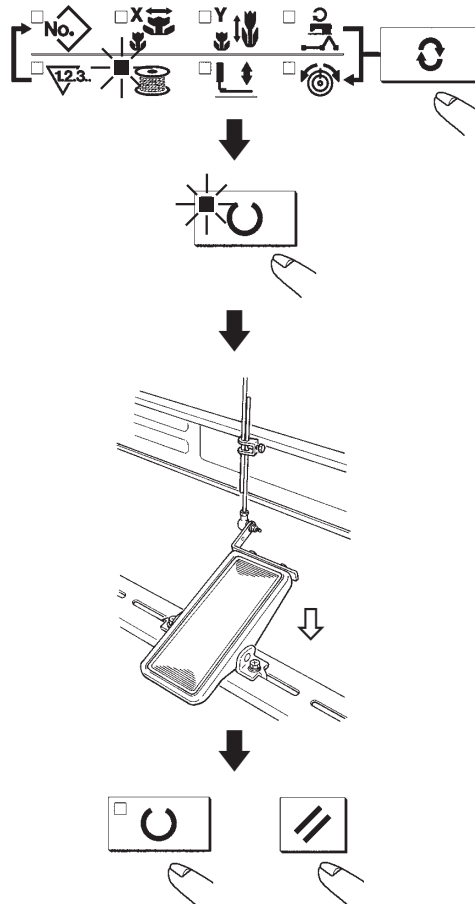
- 1) Press  key to make the SEWING LED go off.
- 2) Select the bobbin winder  with  key.
- ※ Caution: Selection cannot be performed when the Sewing LED is lit up.
- 3) Press  key. The work clamp feet come down and the Sewing LED lights up.
- 4) When the pedal switch is depressed, the sewing machine rotates.
- 5) When the pedal is depressed again, or  key or  key is pressed, the sewing machine stops.
- 6) When  key is pressed, the Sewing LED goes off, the work clamp feet go up and  key becomes effective.



注意：剛剛打開（ON）電源後，卷線不動作。請設定 1 次圖案 No. 等，按  鍵讓縫製 LED 亮燈之後再進行操作。



Caution: Bobbin winder does not work immediately after turning ON the power. Perform the bobbin winding after setting pattern No. or the like once, pressing the  key, and making the sewing LED light up.

6. 夾線裝置

用夾線裝置可以防止高速開始時的縫製不良（上線脫線、跳針、上線髒汙）。夾線在夾線顯示 LED 亮燈的狀態動作，滅燈狀態下不動作。動作 ON/OFF 的變換可以用  鍵來進行。夾線裝置 OFF 時，自動進行低速起動。

6. Thread clamp device

Trouble of sewing (slip-off of needle thread, stitch skipping, or stain of needle thread) at the time of highspeed start can be prevented with the thread clamp device. The thread clamp device works in the state that the thread clamp indication LED lights up and does not work when the LED goes off. Changeover of ON/OFF motion is performed with  key. When the thread clamp device is OFF, the start automatically becomes the slow start.

 注意 Caution	<ol style="list-style-type: none"> 1. 記憶體開關 No.35 設定為 1（禁止）時不進行夾線動作。同時， 鍵無效。 2. 關於記憶體開關請參照「I .[8] 記憶體開關的使用方法」P.49。 <ol style="list-style-type: none"> 1. When memory switch No. 35 is "1" (prohibited), the thread clamp does not work. In addition,  key is ineffective. 2. Memory switch, refer to 「I .[8] HOW TO USE THE MEMORY SWITCH」 p.49.
--	--

• 使用夾上線時的注意事項

- (1) 有（動作）夾線時，請把縫製開始上線的長度調小之後再使用。機針長度過長的話，布料背面的線會被拉出。同時，過長的話，容易把上線夾線的上線端頭縫進縫跡裡。
 - 1) 使有夾線時的機線長度約為 33 ~ 36mm。
 - 2) 更換機線之後等機線變長，或用手拿機線縫製時，請把夾線  鍵設定為 OFF。
 - 3) 如果夾線夾持的上線被縫進縫跡後，請不要強行拉布料，請用剪刀等把縫進布了的上線剪掉。開始縫製的上線不會被縫進縫跡裡。

• Matters that demand special attention when using the needle thread clamp device

- (1) In case of with the needle thread clamp (motion), make shorter the length of needle thread remaining on the needle at the sewing start for use. When the length of needle thread is lengthened, needle thread on the wrong side of material is apt to protrude. In addition, when the length is excessively lengthened, the end of needle thread held by the needle thread clamp may be rolled in the seams.
 - 1) In case of with the needle thread clamp, the standard of the length of needle thread is 33 to 36 mm.
 - 2) When needle thread is long after replacing thread or the like or sewing while holding needle thread by hand, turn OFF the THREAD CLAMP  key.
 - 3) When the needle thread held with the thread clamp is rolled in the seams, do not draw the material forcibly and cut the connecting needle thread with the scissors or the like. The seams are not damaged since it is the needle thread at the sewing start.

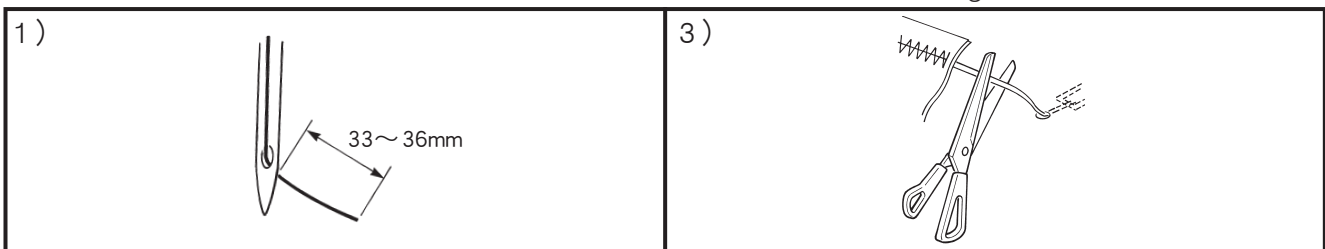

(2) 讓夾線動作，可以保持縫製開始的穩定縫製，可以把機針調整短，因此布料的上線纏線現象變少。但是，對於為了漂亮地捲進上線但是縫跡長度不足的圖案等，布料背面有可能挑出上線，請參考下列事項適當地選擇有無夾線功能。

1) 縫製長度短（約 10mm 以下）時，把機線調短，但是有時也出現鬍鬚狀情況。

(2) It is possible to adjust needle thread shorter by making the needle thread clamp work while holding the stabilized sewing at the start of sewing and the gathering (bird's nest) of needle thread on the wrong side of material can be lessened. However, for the pattern which the stitch length for neatly rolling in needle thread is short, needle thread may protrude from the wrong side of material. Select with/without thread clamp referring to the item below.

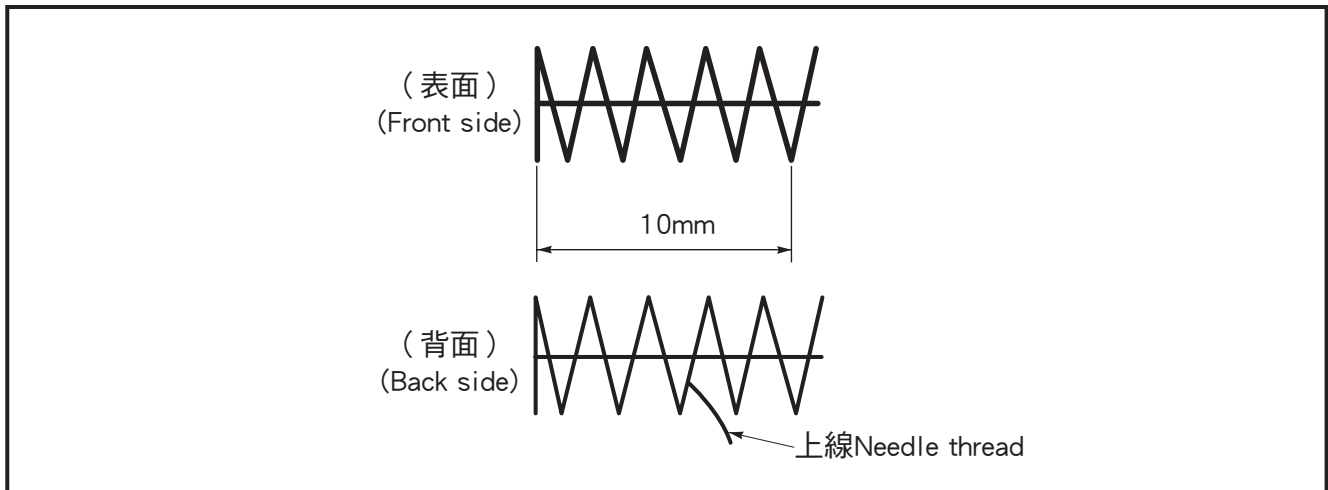

1) When the sewing length is short (less than approximately 10 mm), the end of needle thread may protrude like beard even when adjusting needle thread shorter.



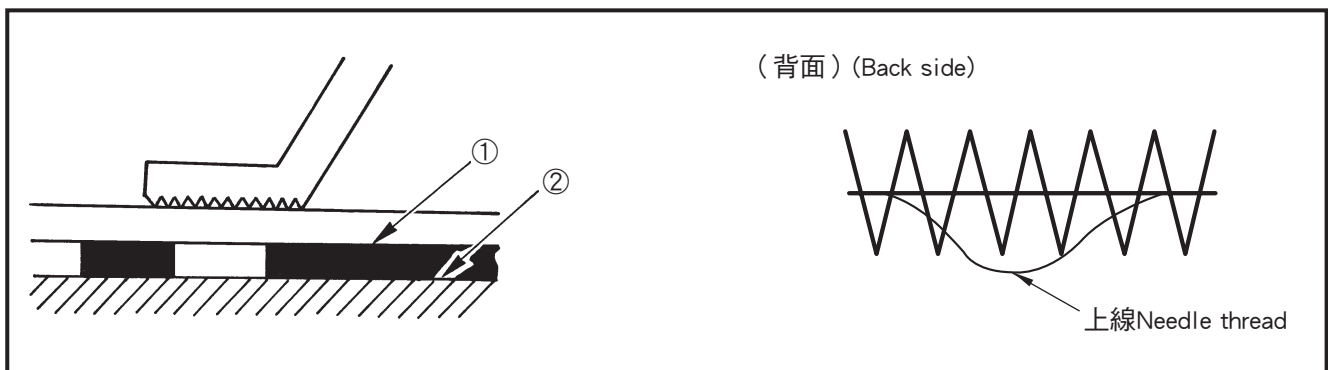

(3) 使用布料不與針板②緊密接觸的下板①時，有可能發生上線鬆弛、不管線長度如何布料背面均捲入上線的現象。

(3) When the type of lower plate ① that material does not come in close contact with throat plate ② is used, needle thread on the wrong side of material may be rolled in the seams regardless of needle thread play or sewing length.



(4) LKS-1903AN (帶釘扣) 時，由於上述 (2) (3) 的原因，標準出貨狀態時設定為禁止夾線動作。(記憶體開關 No.35) 有交叉線 ( 等)、叉形狀 ( 等) 時，布料背面的上線容易被捲進，最好使用夾線功能。

(4) For LKS-1903AN (button sewing), the thread clamp is set to the motion prohibited in the state of standard delivery due to the aforementioned (2) and (3). For (memory switch No. 35) with crossover stitch ( , etc.) or X shape ( , etc.), needle thread on the wrong side of material becomes easy to be rolled in. In this case, it is recommended to use the thread clamp.



(5) 使用夾線功能，縫製開始的底線露出布料表面時，把縫製開始的張力 (2 ~ 3 針) 降低，底線就不明顯了。

(5) When the thread clamp is used, and bobbin thread at the sewing start appears on the right side of material, reduce thread tension at the sewing start (2 to 3 stitches) and bobbin thread becomes less conspicuous.

[設定例] 縫製張力設定為「35」時，縫製開始 1 ~ 2 針的張力為「20」。

[Example of setting] Tension of 1 to 2 stitches at the sewing start is “20” when sewing tension setting is “35” .

※ 縫製開始張力的設定，請參照「 | .[6]-5. 圖案線張力的設定」 P.37。

※ For the setting of tension at the sewing start, refer to 「 | . [6]-5. Setting the pattern thread tension」 p.37

[6] 縫紉機的操作（應用篇）

[6] OPERATION OF THE SEWING MACHINE (ADVANCED)

1. 使用圖案鍵 進行縫製可以把已經登記的圖案（No.1 ~ 200）登記到 P1 ~ P50 上。變更擴大縮小率、最高轉速限制、線張力、縫製位置就可以登記，用圖案 No. 的滾動視窗選擇同樣可以登記圖案，可以一次地叫出 P1 ~ P25。

※ 選擇了 P6 ~ P25 時，用下表所示的 鍵的組合（同時按）進行縫製。



1. Performing sewing using the pattern keys (, , , and) Patterns (No.1 to 200) which have been already registered can be registered to P1 to P50. It is possible to change and register the scale, max. speed limitation, thread tension and sewing position. Same as the patterns (No.1 to 200), P1 to P50 are used by the selection by scrolling the pattern No. The pattern calling from P1 to P25 can be made by one-touch as well.

※When selecting P6 to P25, perform the selection by combination (simultaneous pressing) of , , , and keys as shown in the table below.

P-No.	選擇鍵 Selection key	P-No.	選擇鍵 Selection key	P-No.	選擇鍵 Selection key	P-No.	選擇鍵 Selection key
P1	P1	P8	P1+P4	P15	P4+P5	P22	P2+P3+P4
P2	P2	P9	P1+P5	P16	P1+P2+P3	P23	P2+P3+P5
P3	P3	P10	P2+P3	P17	P1+P2+P4	P24	P2+P4+P5
P4	P4	P11	P2+P4	P18	P1+P2+P5	P25	P3+P4+P5
P5	P5	P12	P2+P5	P19	P1+P3+P4		
P6	P1+P2	P13	P3+P4	P20	P1+P3+P5		
P7	P1+P3	P14	P3+P5	P21	P1+P4+P5		

(1) 往圖案鍵上的登記
設定例：把圖案 No.3、X 擴大縮小 50%、最高速度限制 2000sti/min、線張力“50”、圖案位置右移 0.5mm、前移 1mm 的設定登記到 P2。

(1) Register to the pattern key
Setting example : Register following setting to the P2., Pattern No. 3, X scale rate : 50%, Y Scale rate :80%, Max. speed limitation : 2,000 sti/min, Thread tension : "50", Pattern position : 0.5 mm to the right and 1 mm to the front.

<p>1) 打開 (ON) 電源，按 鍵。 (縫製 LED 應該滅燈) 進入方式設定 (記憶體開關設定)。</p> <p>1) Turn ON the power switch and press key to enter mode setting (memory switchsetting). (Sewing LED should be put out.)</p>	
<p>2) 用 鍵、 鍵顯示出圖案登記模式。</p> <p>2) Indicate the pattern register mode with or key.</p>	
<p>3) 按 鍵。進入圖案登記方式。</p> <p>3) Press key. Enter the pattern register mode.</p>	

- 4) 按 鍵。(選擇登記的 P-No.。)
用 鍵、 鍵也可以選擇。

- 4) Press key. (Select P-No. to be registered.) Selection can be performed with or key.

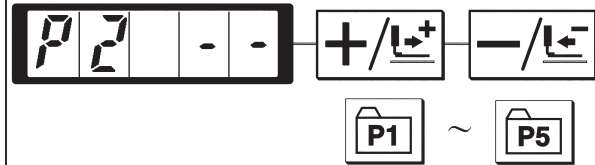

- 5) 按 鍵，顯示圖案 No. 。
用 鍵、 鍵設定為圖案 No. “3”。
- 5) Press key to indicate the Pattern No . Set the Pattern No. to "3" with or key.





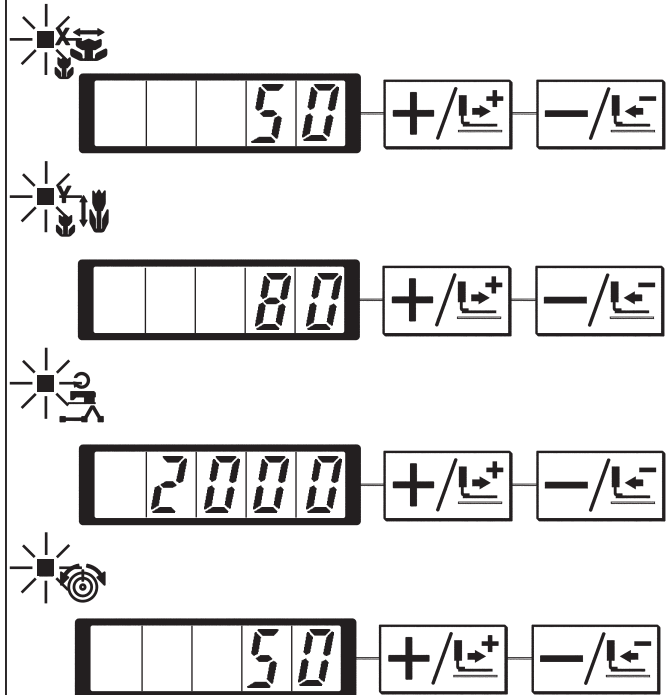

- 6) 按 鍵，用 鍵、 鍵設定為 X 擴大縮小率 “50” %、Y 擴大縮小率 “80” %、最高速度限制 “2000” sti/min、線張力 “50”。
- 6) Press key and set as follows with or key.
X Scale rate : “50” %,
Y Scale rate : “80” %, Max. speed limitation : “2000” sti/ min, Thread tension : “50” .



- 7) 按 鍵之後，變為「X 擴大縮小率 」顯示 0.0。X 方向的移動量可以以 0.1mm 為單位進行設定。用 鍵、 鍵設定為 0.5。
- 7) Press key and “X Scale rate ” indication becomes 0.0. Traveling amount in X direction can be set in 0.1 mm unit. Set 0.5 with or key.

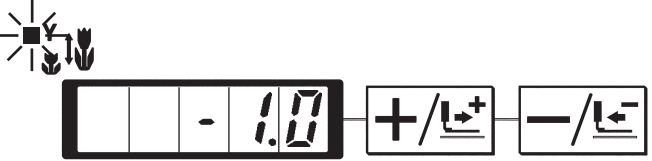

<p>8) 按 C 鍵之後，變為「Y 擴大縮小率 」顯示 0.0。Y 方向的移動量可以以 0.1mm 為單位進行設定。用 +/- 鍵、-/- 鍵設定為 -1.0。</p> <p>8) Press C key and “Y Scale rate   </p>	
<p>9) 按 U 鍵之後，設定結束。</p> <p>9) Press U key to finalize the setting.</p>	
<p>10) 按 M 鍵。結束圖案登記方式。</p> <p>10) Press M key. Pattern register mode is finalized.</p>	
<p>11) 按 M 鍵。結束方式設定，返回待機方式。</p> <p>11) Press M key. Mode setting is finalized and the mode returns to the normal mode.</p>	

(2) 縫製操作

操作例：先以登記的 P2 內容進行縫製，然後縫製 P3 的內容。

- 1) 打開電源。
- 2) 按 **P2** 鍵。
- 3) 按 **U** 鍵，縫製 LED 亮燈後，壓腳移動上升。
- 4) 確認圖案形狀。(請參照「I .[5]-2. 圖案形狀的確認 P.22 之項。)
- 5) 如果圖案形狀正確，則可以縫製。
- 6) 縫製結束後，按 **P3** 鍵，壓腳下降，檢索原點後，移動到縫製開始點，然後壓腳上升。(P 鍵在縫制 LED 亮燈時，也可以按鍵變換圖案。)

(2) Sewing operation

Operation example : After performing sewing with the contents of the registered P2, perform sewing with the contents of P3.

- 1) Turn ON the power switch.
- 2) Press the **P2** key.
- 3) Press the **U** key, and when the sewing LED lights up, the work clamp foot goes up after it has moved.
- 4) Check the contour of the sewing pattern.(Refer to the item " I .[5]-2. Checking the contour of a sewing pattern" p.22.)
- 5) If the contour of the sewing pattern is acceptable, the sewing can be made.
- 6) Press **P3** key after completion of sewing and the presser comes down. The presser moves to the sewing start point after origin retrieval and goes up. (The P keys can operate the pattern change by onetouch even when the sewing LED is lighting up.)

7) 進行 4)、5) 項操作。

※ 也可以指定選擇 P1、P25 的圖案。用 **+/-** 鍵顯示。

→ 0 ~ 200 ↔ P1 ~ P25 ← 沒有登記的 P1 ~ P25 則不顯示。

注意：縫製 LED 亮燈時，按 P1 ~ P25 鍵之後，壓腳下降。請注意不要夾到手指。

※ 參考：P26 ~ P50 可以進行圖案登記。**P1** ~ **P5** 鍵不能登記只能用選擇圖案的方式指定。請用 **+/-** 鍵進行顯示。

→ 0 ~ 200 ↔ P1 ~ P25 ↔ P26 ~ P50 ←

縫製 LED 亮燈時，不能選擇 P26 ~ P50 的圖案。

7) Perform the above items 4) and 5).

※ The P1 to P25 can be indicated on the display when selecting the pattern by pressing the **+/-** or **-/+**

key. → 0 ~ 200 ↔ P1 ~ P25 ← P1 to P25 which have not been registered are not indicated.

Caution: Press P1 to P25 key while the sewing LED lights up and the presser comes down. Be careful that your fingers are not caught in the presser.

※ Reference: Pattern register from P26 to P50 can be performed. Register can not be performed in **P1** to **P5** key. Designate the pattern by the pattern selection only. Indicate the pattern with **+/-** or **-/+** key.

→ 0 ~ 200 ↔ P1 ~ P25 ↔ P26 ~ P50 ←

Pattern selection from P26 to P50 cannot be performed while the sewing LED lights up.

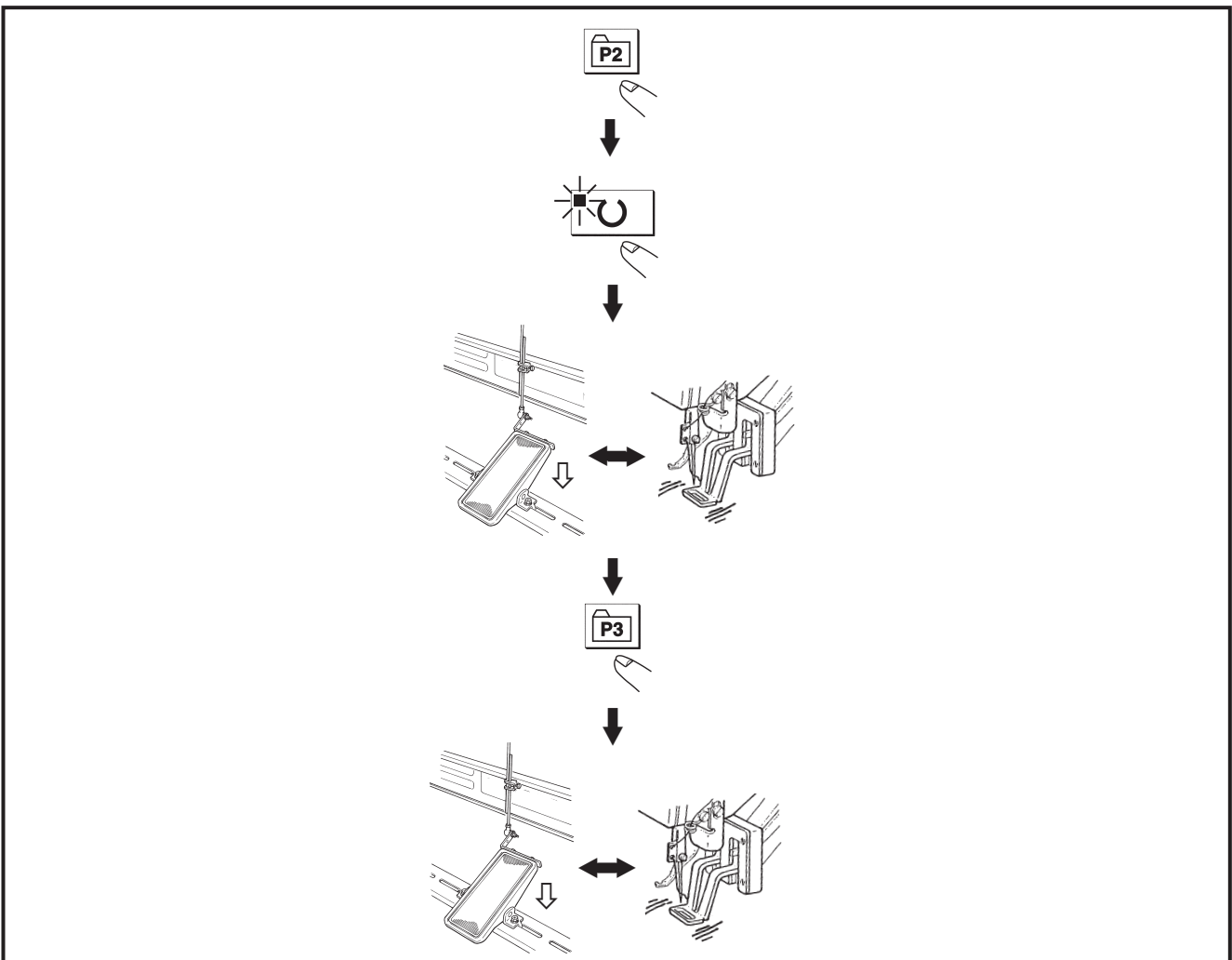

2. 使用組合功能（複合）的縫製
按順序排列已經登記的圖案登記（P1 ~ P50），登記到 C1 ~ C20，每縫製之後按順序變換縫製圖案。1 個組合號碼最多可以登記 30 個圖案。

(1)組合的登記



設定例：按 P1、P2、P3 的順序組合進行登記到 C1。





2. Performing sewing using the combination function

By arranging in the order of use of the pattern register (P1 to P50) which have been already registered and registering in C1 to C20, the sewing pattern will change in the order every time the sewing machine finishes the sewing. One combination No. can be registered up to the maximum 30 patterns.

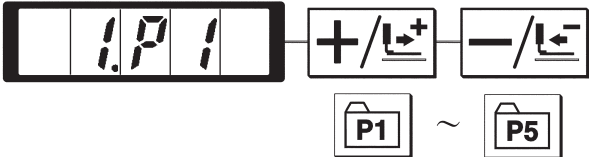
(1) Register of the combination

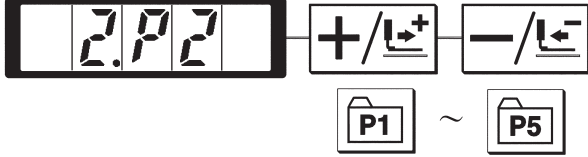
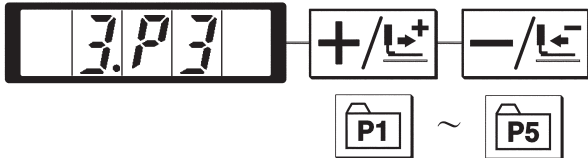
Setting example : Combine in the order of P1, P2 and P3, and register them in the C1.

<p>1) 打開（ON）電源，按 M 鍵。 （縫製 LED 應該滅燈）進入方式設定（記憶體開關設定）。</p> <p>1) Turn ON the power switch and press M key to enter the mode setting (memory switch setting). (Sewing LED should be put out.)</p>	
<p>2) 用 +/- 鍵、-/- 鍵顯示組合方式。</p> <p>2) Indicate the combination mode with +/- or -/- key.</p>	
<p>3) 按 U 鍵。縫製 LED 亮燈，進入組合方式。 用 +/- 鍵、-/- 鍵可以選擇 C1 ~ C20。</p> <p>3) Press U key. Sewing LED lights up to enter the combination mode. C1 to C20 can be selected with +/- or -/- key.</p>	
<p>4) 按 C 鍵，然後按 P1 鍵。 P1 被設定到 C1 的第 1 圖案。 用 +/- -/- 選擇 P1 ~ P50。</p> <p>4) Press C key, and then press P1 key. P1 is set to the first pattern of C1. P1 to P50 can be selected with +/- or -/- key as well.</p>	

<p>5) 按 C 鍵，然後按 P2 鍵。 P2 被設定到 C1 的第 2 圖案。 用 +/- -/- 選擇 P1 ~ P50。</p> <p>5) Press C key, and then press P2 key. P2 is set to the second pattern of C1. P1 to P50 can be selected with +/- or -/- key as well.</p>	
<p>6) 按 C 鍵，然後按 P3 鍵。 P3 被設定到 C1 的第 3 圖案。 用 +/- -/- 選擇 P1 ~ P50。</p> <p>6) Press C key, and then press P3 key. P3 is set to the third pattern of C1. P1 to P50 can be selected with +/- or -/- key as well.</p>	
<p>7) 按 U 鍵結束登記。</p> <p>7) Press U key to finalize the register.</p>	
<p>8) 按 M 鍵。 結束組合登記方式。</p> <p>8) Press M key. Combination register mode is finalized.</p>	
<p>9) 按 M 鍵。 結束方式設定，返回通常方式。</p> <p>9) Press M key. Mode setting is finalized and the mode returns to the normal mode.</p>	

(2) 縫製操作

操作例：以登記的 C1 內容進行縫製。

1) 打開電源。

2) 用 **+ / ←** **- / →** 鍵把圖案號碼設定為

“C1.1”。

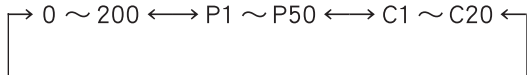

3) 按 **□** **⏻** 鍵，縫製 LED 亮燈，然後壓腳移動，上升。

4) 如果圖案形狀良好，則可以縫製。

5) 按照每次縫製組合的順序進行步驟，1 週圈縫製結束後，返回最初的步驟，可以反覆進行縫製。

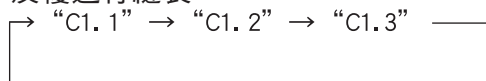

※ 縫製後，如果想返回前面的圖案或跳到下一圖案時，請在縫製 LED 亮燈的狀態按 **+ / ←** 鍵、**- / →** 鍵。圖案顯示變化，壓腳移動到縫製開始點。

※ 登記 C1 ~ C20 後，改變 P1 ~ P50 的內容的話，登記在 C1 ~ C20 中的 P1 ~ P50 的內容也改變，請注意。

※ 每種圖案均應確認圖案形狀。（請參照 I .[5]-2. 圖案形狀的確認 P.22 之項。）

(2) Sewing operation

Operation example : Perform sewing with the contents of the registered C1.

1) Turn ON the power switch.

2) Set the pattern No. to “C1-1 ” using the **+ / ←** or **- / →** key. Scroll as follows :

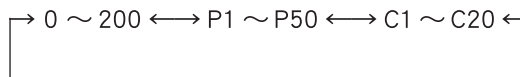

3) Press the **□** **⏻** key. When the sewing LED lights up, the work clamp feet will go up after movement.

4) If the contour of the pattern is acceptable, the sewing can be made.

5) Every time the sewing is finished, the step is made in the order of the combination. After completing one cycle of sewing, the step returns to the first step. The sewing can be made repeatedly.

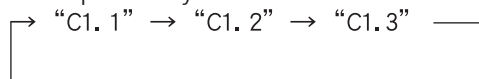







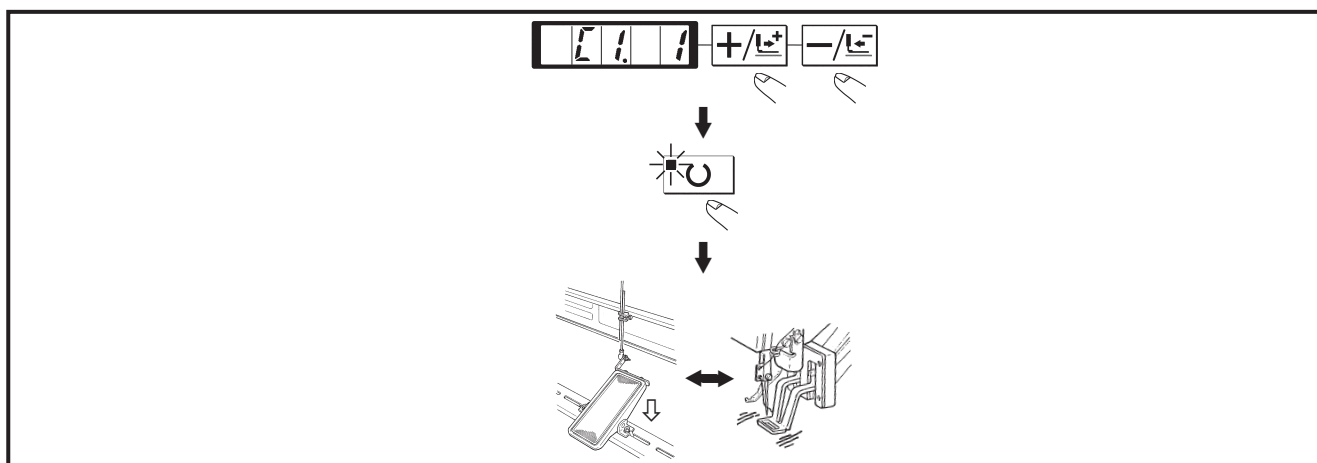





※ When you desire to return the pattern to the previous one or skip the next pattern after sewing, press **+ / ←** or **- / →** key in a state that the sewing LED lights up. The indication of the pattern will change, and the work clamp feet will move to the sewing start point.

※ If the contents of P1 to P50 are changed after registration of C1 to C20, the contents of P1 to P50 used in C1 to C20 will change. So, be careful.

※ Make sure of the contour of the pattern for each of the patterns. (Refer to the item " I .[5]-2.Checking the contour of a sewing pattern" p.22.)



3. 使用「底線計數器」的縫製
 生產計數器可以作為底線計數器使用。反覆縫製同樣的圖案，1 個梭芯可以縫製的次數（設定數）縫制結束後，縫紉機變不能起動。底線計數器採用減算方式。
- (1) 按  鍵，設定為計數器顯示 。
 - (2) 然後按  鍵。
 - (3) 然後，按   鍵，設定一個梭梭可以縫製的次數。
 - (4) 縫製後，每縫一次計數器減一。
 - (5) 縫製完設定數後，踩踏板縫紉機也不開始縫製。
 - (6) 更換底線，按  鍵。計數器值返回到設定值。
 - (7) 反覆(4) ~ (6)的步驟。

3. Performing sewing using the “bobbin thread counter”
 The production counter can be used as the bobbin thread counter. In case a same sewing pattern is sewn in repetition, the sewing machine will stop sewing when the number of times (the specified number) that can be sewn with a bobbin is reached. The bobbin thread counter is of the subtracting method.
- (1) Press  key to indicate the Counter .
 - (2) Then press the  key.
 - (3) Then press the  or  key, and set the specified number of times that can be sewn with a bobbin.
 - (4) Every time the sewing machine finishes a sewing cycle, counting-down is made by one.
 - (5) When the sewing machine finishes the specified number of times, the sewing machine does not start even if depressing the pedal.
 - (6) Replace the bobbin with a new one, and press the  key. The value of the counter returns to the set value.
 - (7) Repeat the steps of procedure from the steps (4) to (6).

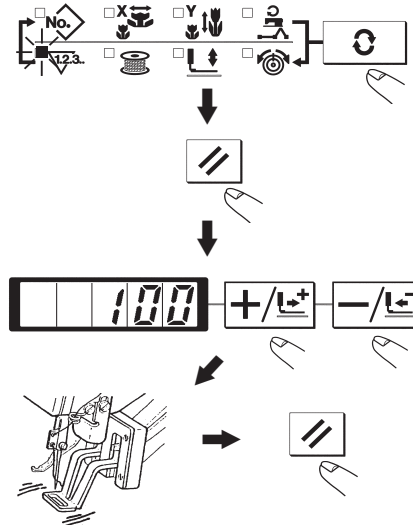



注意：計數器的設定在出貨狀態時設定為生產計數器（加算方式）。作為底線計數器使用時，必須變換記憶體開關 No.18。（請參照「 I .[8] 記憶體開關的使用方法」P.49。）

Caution: The counter at the time of delivery is set to the production counter (adding method). If it is used as the bobbin thread counter, it is necessary to change over memory switch No. 18. (Refer to the item " I .[8] HOW TO USE THE MEMORY SWITCH" p. 49.)





4. 暫停的使用方法

把記憶體開關 No.31 設定為 1 之後， 鍵可以作為暫停鍵來使用。（請參照「I.[8] 記憶體開關的使用方法」P.49。）

- (1) 按 鍵後，縫紉機停止動作。出錯 50 被顯示出來。然後，按 鍵解除出錯。











- (2) 解除後的操作有如下 3 個步驟。

- 1) 按開始開關重新開始縫製。
- 2) 按 鍵，進行切線後，再按  鍵，進行位置調整，然後再按開始開關重新開始。
- 3) 按 鍵，進行切線後，再次按 鍵回歸到原點。



5. 圖案線張力的設定

縫製開始的 6 針和從下縫線曲折縫變換的部分以及縫製結束的加固部分的上線張力可以分別進行設定。

- (1) 縫製 LED 亮燈時，按 鍵，設定為上線張力 顯示。
- (2) 用腳踏開關讓壓腳下降。
注意：如果把腳踏開關踩到最後，縫紉機會開始縫製，請注意安全。
- (3) 用  鍵移動送布。
- (4) 在可以設定張力的位置，「c」被顯示出來。
- (5) 一邊按 鍵，一邊用  鍵設定張力。
- (6) 反覆 (3)(4)(5) 設定張力。
- (7) 設定結束之後，按 鍵。壓腳移動到原點然後上升。





4. How to use the temporary stop

When memory switch No. 31 is set to "1",  key can be used as the temporary stop key. (Refer to "I.[8] HOW TO USE THE MEMORY SWITCH" p.49.)

- (1) Sewing machine stops by means of  key. Error 50 is indicated, the error release is performed using  key.











- (2) There are three operations after the release as below.

- 1) Re-start of sewing by means of the start switch.
- 2) Press  key to perform thread trimming, perform positioning with  or  key, and re-start by means of the start switch.
- 3) Press  key to perform thread trimming, and press again  key to return to the origin.

5. Setting the pattern thread tension

Needle thread tension for 6 stitches at the sewing start, the portion which is changed over from basting stitch to zigzag stitch, and the portion of tie stitch at the sewing end can be individually set.

- (1) While the sewing LED lights up, press  key to indicate the needle thread tension .
- (2) Lower the presser with the foot pedal.
Caution: When the foot pedal is depressed until it will go no further, the sewing machine starts. So, be careful.
- (3) Move the feed with   key.
- (4) "c" is indicated at the position where the tension setting is possible.
- (5) Pressing  key, set the tension with  or  key.
- (6) Repeat steps (3), (4) and (5) to set the tension.
- (7) When setting is completed, press  key. The presser moves to the origin and goes up.

6. 使用時的注意

- (1) 誤顯示亮燈後，請一定查清原因，進行處理。
- (2) 縫製中請不要拉縫製物，有可能使針位置偏斜。萬一針位置偏斜了，請按 2 次  鍵，返回正常的原點位置。
- (3) 在機針降下的狀態，請不要關閉電源。壓腳下降，有挑線桿和機針相碰，斷針等危險。

• 使用轉速的大約速度

縫製物 / 機線 / 機針 Sewn product / thread / needle	機頭部規格 / 縫製速度 Head type / Sewing speed
牛仔布 8 層 / 棉線 #50/DPx5#16 8-layered denim / Cotton thread #50 / DPx5 #16	S (標準) /3200sti/min S (Standard) / 3200 sti/min
毛料 8 層 / 聚酯長纖維線 #50/DPx5#14 8-layered woolen gabardine / Polyester filament #50 / DPx5 #14	S (標準) /2300sti/min S (Standard) / 2300 sti/min
牛仔布 8 層 / 棉線 #20/DPx17#19 8-layered denim / Cotton thread #20 / DPx17 #19	H (厚料) /3200sti/min W (倍旋梭) /2700sti/min H (Heavy-weight material)/3200 sti/min W (Double-capacity hook)/2700 sti/min
牛仔布 6x12 層疊縫 / 棉線 #20/DPx17#19 Overlapped sewing of 6 x 12-layered denim / Cotton thread #20 / DPx17 #19	H (厚料) /2500sti/min H (Heavy-weight material) / 2500 sti/min
編織料 + 肩紐帶 3+1 層 / 聚酯短纖維線 #60/DPx5#11 Tricot + shoulder strap (3 + 1) layered section / Polyester spun #60 / DPx5 #11	F (內衣) /2000sti/min F (Foundation) / 2000 sti/min

※ 為了防止針熱造成的斷線，請根據上述的縫製條件設定縫製速度。

※ 為了防止縫製內衣等時發生跳針，請降下針桿後使用。（請參照「針桿高度」的專案內容。）

6. Cautions in operation

- (1) When the error indicator lamp lights up, be sure to check the cause of trouble and take a proper corrective measure.
- (2) Do not draw, by hand, the material being sewn during sewing. Doing so will cause the needle shift from the correct position. If the needle moves from the correct position, press the  key two times. This will return the needle to the normal origin.
- (3) Do not turn OFF the power in a state that the needle is lowered. The presser comes down and the wiper interferes with needle. As a result, there is a danger of needle breakage or the like.

• Reference for the sewing speed to be applied

※ To prevent the thread breakage due to the needle heat, set the sewing speed referring to the above table in accordance with the sewing conditions.

※ For sewing the foundation or the like, lower the height of the needle bar to prevent the stitch skipping.(Refer to the item “Adjusting the height of the needle bar”)

[7] 維修

[7] MAINTENANCE

1. 針桿高度

把針桿①設到最下點，放鬆針桿緊固螺絲②，把針桿上刻線④和針桿下擋塊③的下端調節成一致。僅 F 規格，請調整到針桿上刻線④中心下降 0.8mm ~ 1mm 的位置。

注意：調節後請一定確認不要有鬆動。

※ 有的縫製條件發生跳針時，請從針桿上刻線④往下調節 0.5mm ~ 1mm。

1. Adjusting the height of the needle bar

Bring needle bar ① to the lowest position of its stroke. Loosen needle bar connection screw ② and adjust so that upper marker line ④ engraved on the needle bar aligns with the bottom end of needle bar bushing, lower ③. For F type only, adjust the needle bar to the position where it is lowered by 0.8 mm to 1 mm from the center of upper marker line ④ engraved on the needle bar.

Caution: After the adjustment, make sure that there is no uneven torque.

※ When stitch skipping occurs in accordance with the sewing conditions, adjust the height of the needle bar so as to lower it by 0.5 to 1 mm from the needle bar engraved line ④.

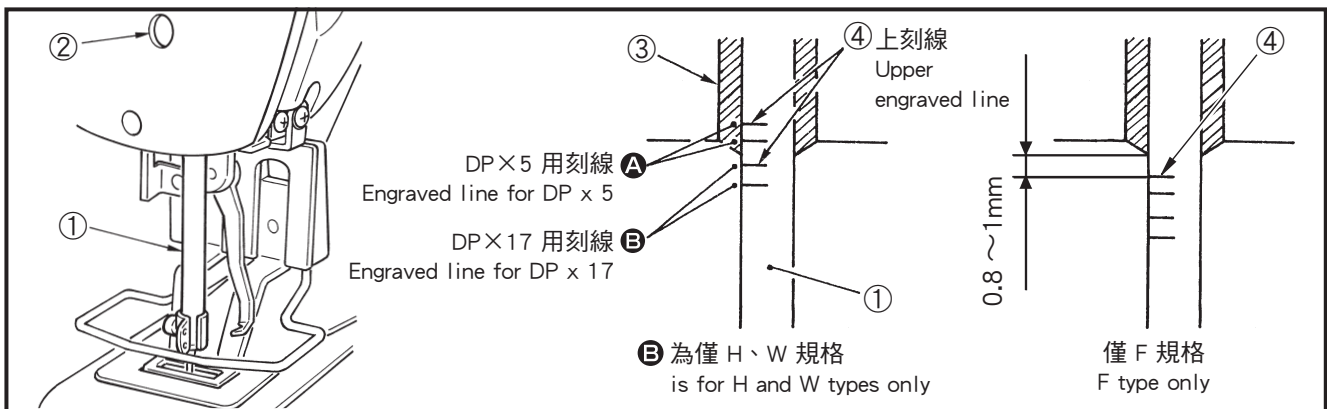

2. 機針與旋梭

(1) 用手轉動手輪，針桿①上升時，把下刻線②對準針桿下擋塊③前端。

2. Adjusting the needle-to-shuttle relation

(1) Turn the handwheel by hand. When needle bar ① has gone up, adjust so that lower marker line ② engraved on the needle bar aligns with the bottom end of the needle bar bushing ③, lower.



警告
WARNING

為了防止突然的起動造成人身事故，請關掉電源後再進行操作。

Turn OFF the power before starting the work so as to prevent accidents caused by abrupt start of the sewing machine.

機針和刻線的關係 Relation between needle and engraved lines

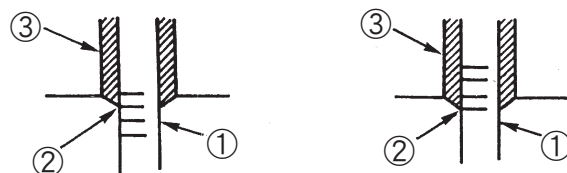

- (2) 放鬆驅動器固定螺絲 ⑪，左右打開中旋梭壓片 ⑫，卸下中旋梭壓腳 ⑬。

- (2) Loosen setscrew ⑪ in the driver. Open inner hook pressers ⑫ to the right and left, and remove inner hook presser ⑬.

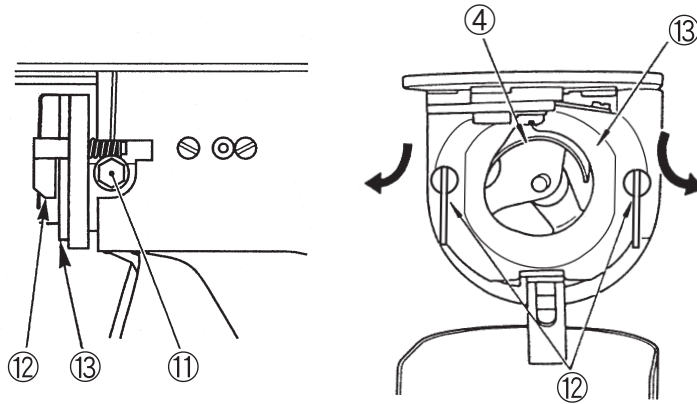

注意：此時請注意不要脫落中旋梭 ④。

Caution: At this time, be careful not to let inner hook ④ come off and fall.

- (3) 為了讓中旋梭 ④ 的梭尖與針 ⑤ 的中心一致，同時防止驅動器 ⑥ 在前端面與機針相碰，弄彎機針，請把驅動器前端面與機針的間隙調整為 0mm，然後把驅動器固定螺絲 ⑭ 鎖緊。

- (3) Adjust so that the blade point of inner hook ④ aligns with the center of needle ⑤, and that a clearance of 0 mm is provided between the front end of the driver ⑥ and the needle as the front end face of driver ⑥ receives the needle to prevent the needle from being bent. Then tighten setscrew ⑭ of the driver.

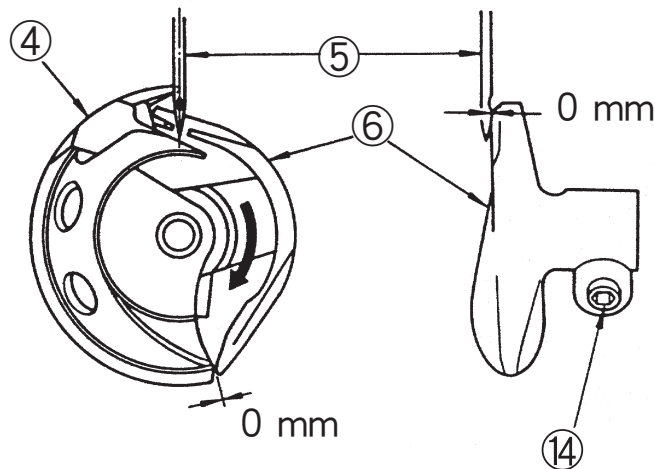

- (4) 放鬆大旋梭固定⑦，左右轉動大旋梭調節軸⑧調節大旋梭的前後位置，把機針⑤和中旋梭④的梭尖間隙調整為 0.05 ~ 0.1mm
- (5) 調節完大旋梭的前位置後，機針和大旋梭的間隙應為 7.5mm，然後鎖緊大旋梭固定螺絲⑦。

- (4) Loosen setscrew ⑦ of the shuttle, and adjust the longitudinal position of the shuttle. To do this adjustment, turn shuttle race adjusting shaft ⑧ clockwise or counterclockwise to provide a 0.05 to 0.1 mm clearance between needle ⑤ and the blade point of inner hook ④ .
- (5) After adjusting the longitudinal position of the shuttle, further adjust to provide a 7.5 mm clearance between the needle and the shuttle by adjusting the rotating direction. Then tighten setscrew ⑦ of the shuttle.

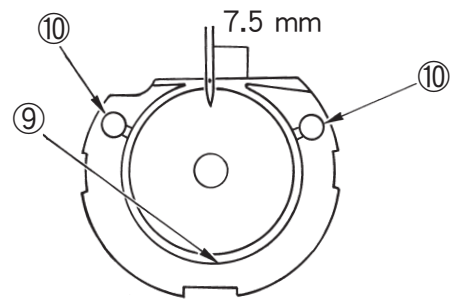
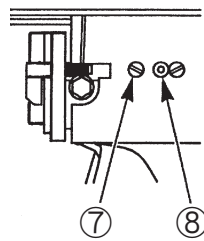
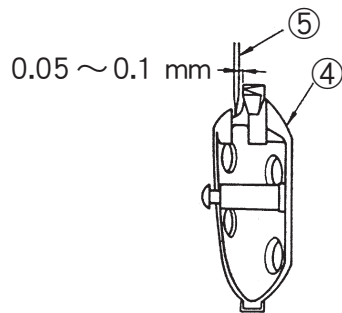

注意：較長時間沒有使用縫紉機或清掃過旋梭周圍之後等時，請往軌道部⑨和油芯⑩加少量的機油後再使用。

Caution: Apply a small amount of oil to race section ⑨ and oil wick ⑩, and use the sewing machine after an extended period of disuse or cleaning the periphery of hook portion.

3. 壓腳的高度

- (1) 在停止狀態，卸下 6 根機架外罩固定螺絲①然後卸下機架外罩②。
- (2) 把 L 形扳手③插入中央的緊固筒④的六角孔螺絲⑤，把它放鬆。
- (3) 把 L 形扳手③向下壓布壓腳升高，向上抬布壓腳降低。
- (4) 調節後，把六角孔螺絲⑤確實鎖緊。
- (5) 左右壓腳不一致時，放鬆固定螺絲⑥，調節布壓腳撥桿擋板⑦調整高度。

3. Adjusting the lift of the work clamp foot

- (1) With the machine in stop mode, remove six setscrews ① of the top cover, and take off top cover ② .
- (2) Apply L-shaped wrench ③ to socket bolt ⑤ of clamp ④ , and loosen the socket bolt.
- (3) Push down L-shaped wrench ③ to increase the lift of the work clamp foot, or pull it up to decrease the lift.
- (4) After the adjustment, securely tighten socket bolt ⑤ .
- (5) If the right and left work clamp feet are not levelled, loosen fixing screw ⑥ and adjust the position of the work clamp foot lever support plate ⑦ to level them.



為了防止意外的起動造成人身事故，請關掉電源後再進行操作。

As the work is performed while the power is ON, never touch the switches other than the necessary one so as to prevent accidents caused by the malfunction of switches.

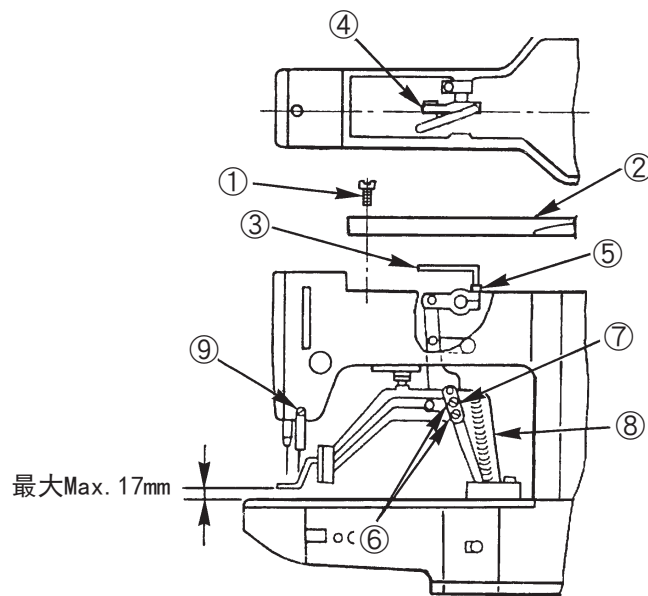

注意：此時，請不要讓布壓腳撥桿擋板⑦與送布台⑧相碰。如果和挑線桿相碰，請用挑線桿安裝台固定螺絲⑨調節挑線桿高度。

Caution: At this time, be careful not to cause work clamp foot lever support plate ⑦ to interfere with feed bracket ⑧ . If the work clamp foot lever support plate interferes with the wiper, readjust the height of the wiper using setscrew ⑨ in the wiper installing base.

4. 移動刀和固定刀

- (1) 放鬆調節螺絲③，向箭頭方向移動活動刀，把從針板前端到切線小撥桿①前端的距離調整為 18.5mm。
- (2) 放鬆固定螺絲⑤，移動固定刀，把針孔導線器②和固定刀④之間間隙調整為 0.5mm。

4. The moving knife and counter knife

- (1) Loosen adjusting screw ③ so that a clearance of 18.5 mm is provided between the front end of the throat plate and the top end of thread trimmer lever, small ① . To adjust, move the moving knife in the direction of arrow.
- (2) Loosen setscrew ⑤ so that a clearance of 0.5 mm is provided between needle hole guide ② and counter knife ④ . To adjust, move the counter knife.



警告
WARNING

為了防止突然的起動造成人身事故，請關掉電源後再進行操作。

Turn OFF the power before starting the work so as to prevent accidents caused by abrupt start of the sewing machine.

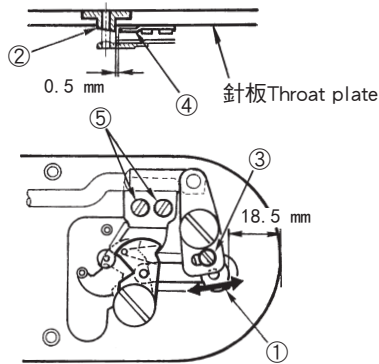

5. 夾線裝置

- (1) 在夾線前端①，線被夾的話，會發生夾線不良，縫製開始的縫製故障。請用鑷子等夾掉。
- (2) 清除夾線裝置的線屑，線灰塵時，請卸下針板之後再進行清除。

5. Needle thread clamp device

- (1) When thread is caught at top end ① of the thread clamp, thread clamp becomes incomplete and sewing trouble at the sewing start will be caused. Remove it with tweezers or the like.
- (2) When removing thread waste or thread dust collected on the thread clamp device, remove it after removing the throat plate.



警告
WARNING

為了防止突然的起動造成人身事故，請關掉電源後再進行操作。

Turn OFF the power before starting the work so as to prevent accidents caused by abrupt start of the sewing machine.

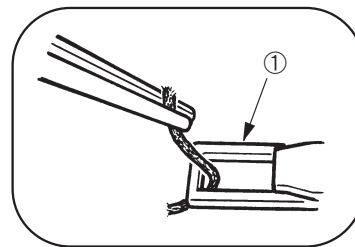
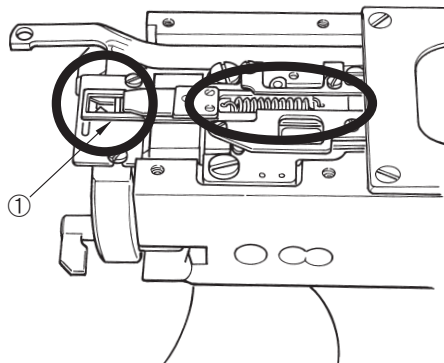

6. 挑線桿的調整

(1) 放鬆螺絲①把挑線桿和機針的間隙調整為 1.5mm 以上。此時的挑線桿和機針的距離大約為 23 ~ 25mm，通過較寬的調整，在壓腳下降時可以防止壓到綫機線。特別是使用細針時，請調寬到 23mm 左右。

※ 機針為縫製結束停止的位置。

6. Adjustment of the wiper

(1) Loosen screw ① to adjust so that a clearance of 1.5 mm or more is provided between the wiper and the needle. At this time, the standard of the distance between the wiper and the needle is 23 to 25 mm. By adjusting the distance wider, the work clamp foot can prevent stepping on needle thread when it comes down. Especially when the thin needle is used, adjust the distance wide to such an extent of 23 mm.

※The position of the needle is when the sewing machine has stopped after the sewing finished.



警告
WARNING

為了防止突然的起動造成人身事故，請關掉電源後再進行操作。

Turn OFF the power before starting the work so as to prevent accidents caused by abrupt start of the sewing machine.

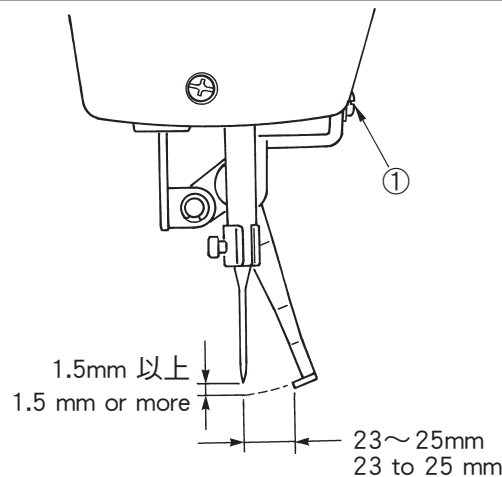

7. 廢油的處理

積油杯①裡積滿了油之後，請卸下積油杯①排放出廢油。

7. Draining waste oil

When polyethylene oiler ① becomes filled with oil, remove polyethylene oiler ① and drain the oil.

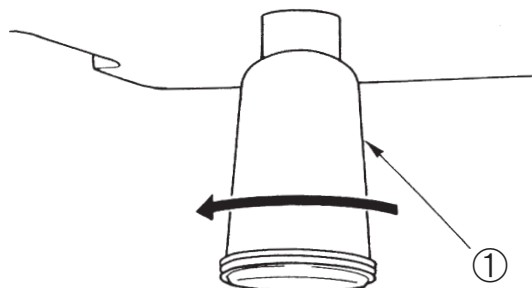

8. 旋梭的加油量

- (1) 放鬆固定螺絲①，卸下固定螺絲①。
- (2) 鎖緊調整螺絲②之後，加油管左④的油量被弄小。
- (3) 調整後，鎖緊固定螺絲①固定好。

8. Amount of oil supplied to the hook

- (1) Loosen setscrew ① and remove setscrew ①.
- (2) When screwing in adjustment screw ②, the amount of oil of oil pipe, left ④ can be reduced.
- (3) After the adjustment, screw in setscrew ① and fix it.

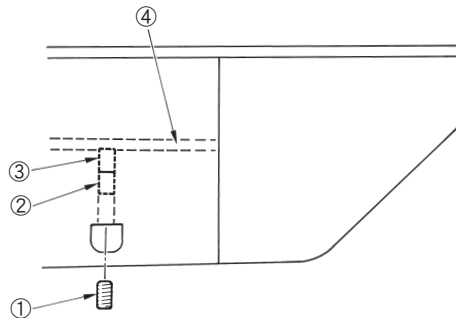

注意：1. 在標準出貨狀態，輕輕鎖緊③回轉 4 圈的位置。

2. 弄小油量時，不要一次鎖緊，鎖緊③回轉 2 圈，待半日左右觀看一下。鎖得過緊的話會磨損旋梭油管。

Caution: 1. The state of standard delivery is the position where ③ is lightly screwed in and returned by 4 turns.

2. When reducing the amount of oil, do not screw in the screw at once. Observe the state for approximately half a day at the position where ③ is screwed in and returned by 2 turns. If reducing is excessive, worn-out of the hook will result.

9. 保險絲的更換

使用 3 個保險絲。

- ① 步進馬達電源保護用 5A（延時保險絲）。
- ② 電磁鐵，步進馬達電源保護用 3.15A（延時保險絲）。
- ③ 控制電源保護用 2A（速斷型保險絲）。

9. Replacing the fuse

The machine uses the following three fuses

- ① For pulse motor power supply protection 5A (time-lag fuse)
- ② For solenoid and pulse motor power supply protection 3.15A (time-lag fuse)
- ③ For control power supply protection 2A (fast-blow type fuse)



危險
DANGER

1. 為了防止觸電事故，關掉電源 5 分鐘之後再打開外罩。

2. 請一定關掉電源開關之後再打開控制箱的蓋子，更換規定容量的保險絲。

1. To avoid electrical shock hazards, turn OFF the power and open the control box cover after about five minutes have passed.

2. Open the control box cover after turning OFF the power without fail. Then, replace with a new fuse with the specified capacity.

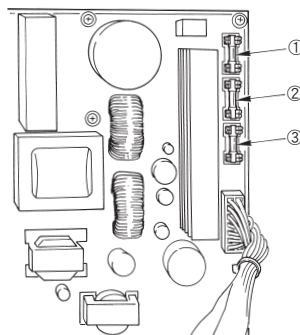

10. 向指定部位補充潤滑脂

使用縫紉機進行了一定的縫製次數之後，打開電源時操作盤上會顯示出異常代碼 No.E220。這是通知需要向指定部位補充潤滑脂，此時請一定補充下列的潤滑脂，叫出記憶體開關 No.245，用復位鍵復位到「0」。顯示出異常 No.E220 顯示後，按重定鍵可以解除異常，但是再次打開電源後會再次顯示出 No.E220。

而且，異常 No.E220 顯示，繼續縫製一定期間後會顯示出異常 No.E221，按復位鍵後即不能解除異常，同時縫紉機變成不能動作。

因此，顯示出異常 No.E221 之後，請一定向下列部位補充潤滑脂，然後啟動記憶體開關 No.245，用復位鍵復位到「0」。

- 注意 :1. 補充潤滑脂之後，如果不把記憶體開關 No .245 變更為「0」，異常 No.E220 或 No. E221 會被再次顯示。
2. 下列指定部位補充潤滑脂時，請使用附屬的潤滑脂軟管（貨號 40013640）。如果補充了指定以外的潤滑脂的話，有可能造成零部件損壞。

10. Replenishing the designated places with grease

When the sewing machine has been used for a certain number of times of sewing, error code No. E220 is displayed on the operation panel at the time of turning ON the power. This display informs the operator of the time of replenishing the designated places with grease. Be sure to replenish the places with the grease below. Then call the memory switch No. 245 and set it to "0" with the RESET key. Even after the display of the error No. E220, when the RESET key is pressed, the error is released, and the sewing machine can be continuously used. Afterwards, however, the error No. E220 is displayed every time the power is turned ON.

In addition, when the sewing machine is used further for a certain period of time after the display of error No. E220, the error No. E221 is displayed and the sewing machine fails to operate since the error cannot be released even when the RESET key is pressed.

When the error No. E221 is displayed, be sure to replenish the designated places below with grease. Then start up the memory switch and set No. 245 to "0" with the RESET key.

- Caution:1. After replenishing the places with grease, the error No. E220 or No. E221 is displayed again unless the memory switch No. 245 is changed to "0".
2. Use grease tube (Part No. 40013640) supplied as accessories to replenish the designated places below with grease. If grease other than the designated one is replenished, damage of components will be caused.



為了防止突然的起動造成人身事故，請關掉電源後再進行操作。

Turn OFF the power before starting the work so as to prevent accidents caused by abrupt start of the sewing machine.

- (1) 向偏心凸輪部加潤滑脂
1) 打開曲柄桿護罩 ①。

- (1) Replenishing the eccentric cam section with grease
1) Open crank rod cover ①.

- 2) 卸下曲柄桿四周②的潤滑脂注入口蓋固定螺絲 ③。
- 3) 向接頭④裡充填潤滑脂 B 軟管⑤中的潤滑脂。
- 4) 請把附屬的螺絲⑥鎖進接頭，然後補充潤滑脂。
- 5) 補充完潤滑脂後，請把剛才取下的固定螺絲③牢固地固定好。

- 2) Remove setscrew ③ from the grease inlet cover located at periphery of crank rod ② .
- 3) Fill coupling ④ with grease through Grease B tube ⑤ .
- 4) Sink screw ⑥ supplied with the unit into the coupling to add the grease.
- 5) After adding the grease, securely tighten set-screw ③ which has been removed.

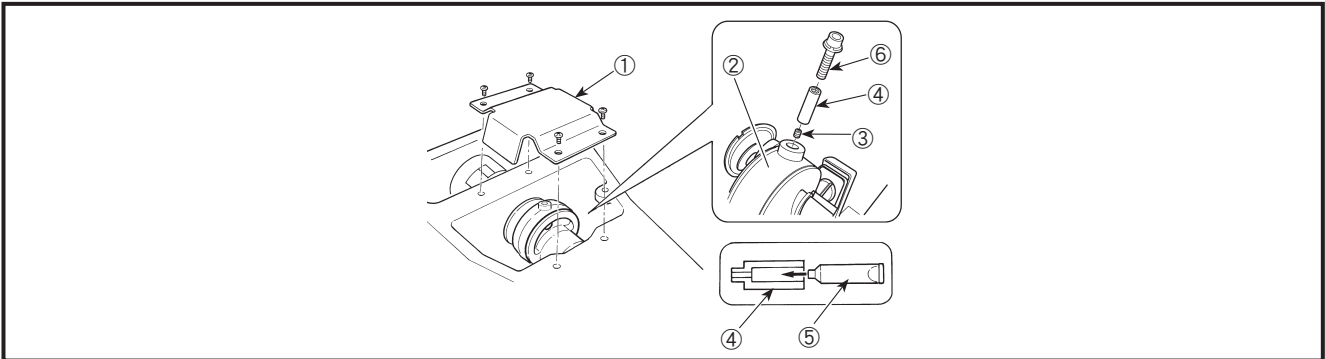

(2) 向大擺動銷部加潤滑脂

- 1) 放倒縫紉機，卸下潤滑脂護罩①。
- 2) 卸下大擺動齒輪②的固定螺絲③。
- 3) 向接頭④裡充填潤滑脂 B 軟管⑤中的潤滑脂。
- 4) 請把附屬的螺絲⑥鎖進接頭，然後補充潤滑脂。
- 5) 補充完潤滑脂後，請把剛才取下的固定螺絲③牢固地固定好。
- 6) 請把潤滑脂護罩①安裝到毛氈⑧可以接觸到齒輪⑦的位置。

(2) Replenishing the oscillator pin section with grease

- 1) Tilt the machine head and remove the grease cover ① .
- 2) Remove setscrew ③ in oscillator gear ② .
- 3) Fill coupling ④ with grease through Grease B tube ⑤ .
- 4) Sink screw ⑥ supplied with the unit into the coupling to add the grease.
- 5) Securely tighten setscrew ③ which has been removed after replenishing with the grease.
- 6) Install grease cover ① at the location where felt ⑧ comes in contact with gear ⑦ .

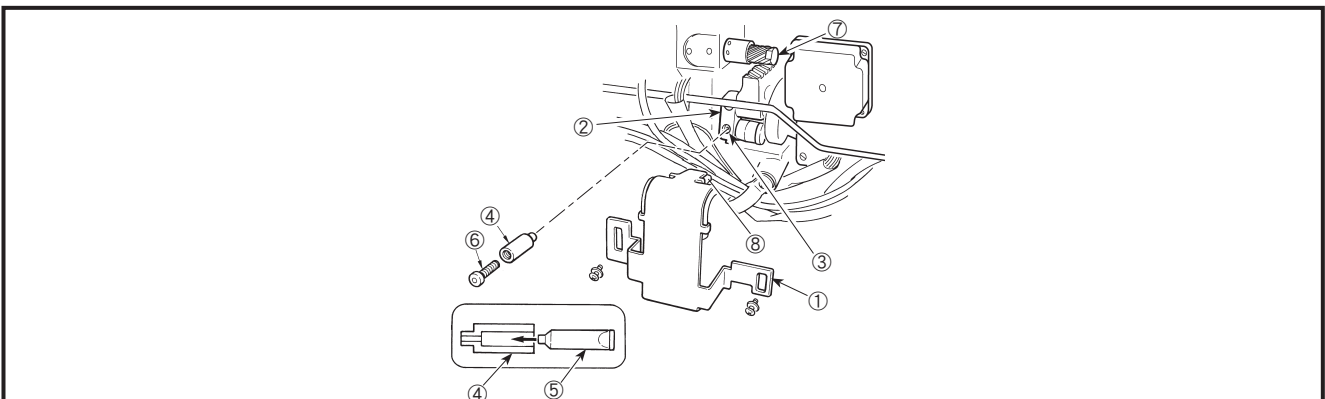

注意 :1. 請不要用強力往齒輪⑦按壓毛氈 ⑧。否則有可能造成不能轉動的故障。

2. 毛氈⑧上塗抹著潤滑脂 A。請不要往上面塗抹潤滑脂 B。

Caution:1. Do not strongly press felt ⑧ against gear ⑦ . It can cause a moving failure.

2. Grease A is applied to felt ⑧ . Do not add grease B to the felt.

[8] 記憶體開關的使用方法



[8] HOW TO USE THE MEMORY SWITCH

- 變更記憶體開關的設定，可以變更縫紉機的動作方法。

- The sewing machine operation can be changed by changing the setting of the memory switch.

1. 記憶體開關的啟動和變更

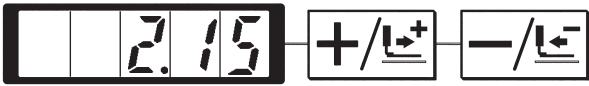
1. Start and change of the memory switch

<p>1) 縫製 LED 滅燈的狀態下，按 M 之後，成為記憶體開關的設定方式。</p> <p>※ 按「M」鍵之後，顯示的 1.30 表示存儲器開關第 1 號的最高速度限制為 3200sti/min（工廠出貨狀態）</p> <p>1) When M key is pressed in the state that the sewing LED is put out, the memory switch setting mode is obtained.</p> <p>※ 32 which is indicated when "M" key is pressed indicates that the max. speed limitation of the first memory switch is 3,200 sti/min. (State at the time of delivery from the factory)</p>	 <p>上3位元是存儲器開關號碼 Three figures from the top are memory switch Nos.</p> <p>下 2 位元是設定內 Two figures from the bottom are contents of setting.</p>
<p>2) 記憶體開關號碼可以用 +/- 鍵、-/- 鍵進行變更。</p> <p>2) Change the memory switch No. with +/- or -/- key.</p>	
<p>3) 按 U 鍵，調整想變更的記憶體開關號碼。縫製 LED 亮燈。</p> <p>3) Adjust the memory switch No. to the No. you desire to change, and press U key. The sewing LED lights up.</p>	
<p>4) 用 +/- 鍵、-/- 鍵變更記憶體開關的內容。</p> <p>4) Change the contents of the memory switch with +/- or -/- key.</p>	
<p>5) 按 ↙ 鍵，可以返回到工廠出貨設定值。</p> <p>5) The value can be returned to the value at the time of delivery from the factory with ↙ key.</p>	
<p>6) 按 U 鍵，登記變更內容。縫製 LED 滅燈，返回記憶體開關號碼的選擇狀態。</p> <p>6) Press U key to register the contents of change. Sewing LED goes off and the mode returns to the selective state of the memory switch No.</p>	
<p>7) 按 M 鍵，結束記憶體開關設定方式，返回到通常狀態。</p> <p>7) Press M key to finalize the memory switch setting mode and the mode returns to the normal mode.</p>	

2. 記憶體開關的設定例



(1) 縫製速度上限的設定

設定例：把縫製速度的上限設定到 1800sti/min。

2. Example of the memory switch setting

(1) Setting the max. sewing speed limitation

Setting example : Setting the max. sewing speed limitation to 1,800 sti/min.

<p>1) 在縫製 LED 滅燈的狀態按 M 鍵。 記憶體被啟動，顯示記憶體開關 No.1 的內容。縫紉機的最高速度限制用記憶體 No.1 設定，所以不需要變更，但是可以變換用 + / ← 鍵、- / → 鍵顯示的記憶體開關 No.。</p> <p>1) Press M key in the state that the sewing LED is put out. The memory switch is started and the contents of memory switch No. 1 are indicated. It is not necessary to change the sewing speed since the max. speed limitation of the sewing machine is set with memory switch No. 1. The indicated memory switch No. can be changed over with + / ← or - / → key.</p>	
<p>2) 記憶體開關 No.1 被顯示的狀態下，按 □ U 鍵，點亮縫製 LED。記憶體開關 No.1 的內容（縫紉機的最高速度限制值）被顯示。</p> <p>2) Press □ U key in the state that memory switch No. 1 is indicated to make the sewing LED light up. The contents of memory switch No. 1 (max. sewing speed limitation value of the sewing machine) are indicated.</p>	
<p>3) 用 + / ← 鍵、- / → 鍵設定為“1800”。</p> <p>3) Set "1800" with + / ← or - / → key.</p>	
<p>4) 按 □ U 鍵登記。縫製 LED 滅燈。</p> <p>4) Register the value with □ U key. Sewing LED goes off.</p>	
<p>5) 按 M 鍵，返回待機狀態。</p> <p>5) Press M key to return to the normal state.</p>	



注意：在待機狀態，縫紉機速度不能設定到該值以上。

Caution: The sewing machine speed in the normal state cannot be increased more than the value which has been set here.

(2) 縫製開始緩啟動速度的設定
 縫製開始的第 1 針~第 5 針的速度可以以 100sti/min 為單位進行設定。可以設定為有夾線和沒有夾線。(參照「I.[8]-3. 記憶體開關功能一覽表」 P.55)

(2) Setting the soft start speed at the sewing start
 The speed of the first stitch to the fifth stitch at the sewing start can be set in a unit of 100 sti/min. Two kinds of settings, in case of with needle thread clamp and of without needle thread clamp can be performed. (See " I .[8] -3. Table of functions of the memory switch" p.55.)

有夾線時單位 : sti/min

In case of with needle thread clamp Unit : sti/min



	出貨狀態 State when delivered	設定範圍 Setting range
第 1 針 1st stitch	1500	400 ~ 1500
第 2 針 2nd stitch	3200	400 ~ 3200
第 3 針 3rd stitch	3200	400 ~ 3200
第 4 針 4th stitch	3200	400 ~ 3200
第 5 針 5th stitch	3200	400 ~ 3200







注意：最高轉速、記憶體開關 No.1 (最高速度限制) 優先。

設定例：有夾線時，變更為第 1 針 1500 → 1000sti/min、第 2 針 3200 → 2000sti/min。

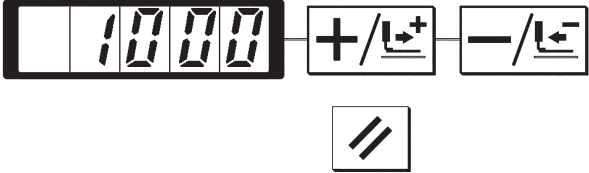
Caution:For the max. sewing speed, the memory switch No. 1 (max. sewing speed limitation) has priority.

Setting example : In case of with needle thread clamp, the speed is changed as follows.1st stitch from 1,500 to 1,000 sti/min and 2nd stitch from 3,200 to 2,000 sti/min.

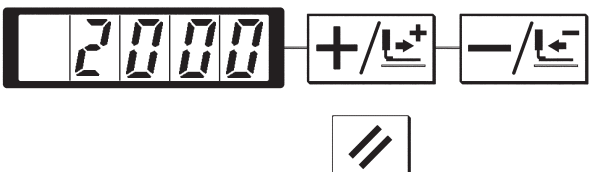
1) 縫製 LED 滅燈的狀態下，按 M 鍵。 1) Press M key in the state that the sewing LED is put out.	
2) 用 + / - 鍵、 - / - 鍵顯示出記憶體開關 No.2。這裡設定第 1 針的縫紉機速度。 2) Indicate memory switch No. 2 with + / - or - / - key.Here, set the sewing speed of the first stitch.	
3) 按 U 鍵。縫製 LED 亮燈，第 1 針的設定值被顯示出來。 3) Press U key. The sewing LED lights up and the set value of the first stitch is indicated.	









<p>4) 用 +/- 鍵、-/- 鍵顯示出 “1000” 。按 ↘ 鍵則返回工廠出貨時的初期值。按 M 鍵之後，現在的操作全被取消，返回 2) 的狀態。</p> <p>4) Indicate "1000" with +/- or -/- key. The value returns to the initial value at the time of delivery from the factory with ↘ key. Press M key to cancel the operation here and return to the state of step 2).</p>	
<p>5) 按 U 鍵。縫製 LED 亮燈，第 1 針的設定值被登記。</p> <p>5) Press U key. The sewing LED goes off and the set value of the first stitch is registered.</p>	
<p>6) 用 +/- 鍵、-/- 鍵顯示出記憶體開關 No.3。這裡設定第 2 針的縫紉機速度。</p> <p>6) Indicate memory switch No. 3 with +/- or -/- key. Here, set the sewing speed of the second stitch.</p>	
<p>7) 按 U 鍵。縫製 LED 亮燈，第 2 針的設定值被顯示出來。</p> <p>7) Press U key The sewing LED lights up and the set value of the second stitch is indicated.</p>	
<p>8) 用 +/- 鍵、-/- 鍵顯示出 “2000” 。按 ↘ 鍵則返回工廠出貨時的初期值。按 M 鍵之後，現在的操作全被取消，返回 6) 的狀態。</p> <p>8) Indicate "2000" with +/- or -/- key. The value returns to the initial value at the time of delivery from the factory with ↘ key. Press M key to cancel the operation here and return to the state of step 6).</p>	
<p>9) 按 U 鍵。縫製 LED 滅燈，第 2 針的設定值被登記。</p> <p>9) Press U key. The sewing LED goes off and the set value of the second stitch is registered.</p>	
<p>10) 按 M 鍵。結束記憶體開關設定方式，返回待機狀態。</p> <p>10) Press M key. The memory switch setting mode is finalized and the mode returns to the normal mode.</p>	

(3) 是否可以呼出圖案資料的設定
 設定為不能呼出不要的圖案，防止錯誤的
 圖案呼出。另外，可以呼出能夠使用的需
 要圖案。

(3) Setting whether the calling of pattern data
 is operative or not
 By making inoperative the calling of the
 unnecessary pattern, this setting prevents
 the different pattern from calling by
 mistake. Also, it is possible to call and use
 the necessary pattern.

設定例：把圖案 No.2、3 設定為不能呼出。

Setting example: Make the calling of pattern
 Nos. 2 and 3 inoperative.





<p>1) 在縫製 LED 滅燈的狀態下，按 M 鍵。</p> <p>1) Press M key in the state that the sewing LED is put out.</p>	
<p>2) 用 +/- 鍵、-/- 鍵顯示出記憶體開關 No.201。</p> <p>2) Indicate memory switch No. 201 with +/- or -/- key.</p>	
<p>3) 按 U 鍵。縫製 LED 亮燈，圖案 No.1 的設 定值被顯示出來。</p> <p>設定值 1：可以讀出，0：不能讀出。</p> <p>3) Press U key. The sewing LED lights up and the set value of pattern No. 1 is indicated.</p> <p>Set value 1: Calling is operative. Set value 0: Calling is inoperative.</p>	
<p>4) 用 +/- 鍵、-/- 鍵設定為圖案 No.2。</p> <p>4) Set pattern No. 2 with +/- or -/- key.</p>	
<p>5) 按 C 鍵，把設定值設定為 0。</p> <p>5) Set the set value to "0" with C key.</p>	
<p>6) 用 +/- 鍵、-/- 鍵設定圖案為 No.3。</p> <p>6) Set pattern No. 3 with +/- or -/- key.</p>	
<p>7) 按 C 鍵，把設定值設定為 0。</p> <p>7) Set the set value to "0" with C key.</p>	
<p>8) 按 U 鍵，登記設定值。縫製 LED 滅燈。</p> <p>8) Press U key to register the set value. The sewing LED goes off.</p>	
<p>9) 按 M 鍵。結束記憶體開關設定方式，返回待機狀態。</p> <p>9) Press M key. The memory switch setting mode is finalized and the mode returns to the normal mode.</p>	

(4) 計數器動作的設定

設定例：把生產計數器（加算方式）變更為底線計數器（減算方式）。

(4) Setting the counter operation

Setting example : The production counter (adding method) can be changed to the bobbin thread counter (subtracting method).

<p>1) 在縫製 LED 滅燈的狀態下，按 M 鍵。</p> <p>1) Press M key in the state that the sewing LED is put out.</p>	
<p>2) 用 +/- 鍵、-/- 鍵顯示出記憶體開關 No.18。</p> <p>2) Indicate memory switch No. 18 with +/- or -/- key.</p>	
<p>3) 按 U 鍵。縫製 LED 亮燈，計數器動作的設定值被顯示出來。</p> <p>3) Press U key. The sewing LED lights up and the set value of counter motion is indicated.</p>	
<p>4) 按 +/- 鍵把設定值設定為 1。</p> <p>設定值 0：縫製計數器，1：底線計數器。</p> <p>4) Set the set value to "1" with +/- key.</p> <p>Set value 0 : Production counter Set value 1 : Bobbin thread counter</p>	
<p>5) 按 U 鍵，登記設定值。縫製 LED 滅燈</p> <p>5) Press U key to register the set value. The sewing LED goes off.</p>	
<p>6) 按 M 鍵。結束記憶體開關設定方式，返回待機狀態。</p> <p>6) Press M key. The memory switch setting mode is finalized and the mode returns to the normal mode.</p>	

3. 記憶體開關功能一覽表

- 用記憶體開關可以以程式設定縫紉機各種動作。
- 出貨時的初期值，不同機種有不同的設定專案。

3. Table of functions of the memory switch

- Various operations of sewing machine can be set in programs by operating the memory switches.
- There are items that change the initial values at the time of delivery according to the models.

顯示 Indication	功能 Function	設定範圍 Setting range	出貨狀態 State when delivered	備考 Remarks
132	縫製的最高速度 (可以以100sti/min為單位設定) Max. sewing speed (Speed can be set in a unit of 100 sti/min.)	400 ~ 3200	3200	LKS-1903AN 和LKS-1900ANW 設定為 2700。 For LKS-1903AN and LKS-1900ANW set to 2700.
215	第1針的縫製速度。(夾線) (可以以100sti/min為單位設定) Sewing speed of 1st stitch (With needle thread clamp) (Speed can be set in a unit of 100 sti/min.)	400 ~ 1500	1500	
332	第2針的縫製速度。(夾線) (可以以100sti/min為單位設定) Sewing speed of 2nd stitch (With needle thread clamp) (Speed can be set in a unit of 100 sti/min.)	400 ~ 3200	3200	
432	第3針的縫製速度。(夾線) (可以以100sti/min為單位設定) Sewing speed of 3rd stitch (With needle thread clamp) (Speed can be set in a unit of 100 sti/min.)	400 ~ 3200	3200	
532	第4針的縫製速度。(夾線) (可以以100sti/min為單位設定) Sewing speed of 4th stitch (With needle thread clamp) (Speed can be set in a unit of 100 sti/min.)	400 ~ 3200	3200	
632	第5針的縫製速度。(夾線) (可以以100sti/min為單位設定) Sewing speed of 5th stitch (With needle thread clamp) (Speed can be set in a unit of 100 sti/min.)	400 ~ 3200	3200	
7--	第1針的線張力。(夾線) Thread tension of 1st stitch (With needle thread clamp)	0 ~ 200	200	
8--	切線時的線張力 Thread tension at the time of thread trimming	0 ~ 200	0	
9--	切線時的線張力變換同步時間 Changeover timing of thread tension at the time of thread trimming	-6 ~ 4	0	
10.4	第1針的縫製速度。(不夾線) (可以以100sti/min為單位設定) Sewing speed of 1st stitch (Without needle thread clamp) (Speed can be set in a unit of 100 sti/min.)	400 ~ 1500	400	
11.9	第2針的縫製速度。(不夾線) (可以以100sti/min為單位設定) Sewing speed of 2nd stitch (Without needle thread clamp) (Speed can be set in a unit of 100 sti/min.)	400 ~ 3200	900	
12.32	第3針的縫製速度。(不夾線) (可以以100sti/min為單位設定) Sewing speed of 3rd stitch (Without needle thread clamp) (Speed can be set in a unit of 100 sti/min.)	400 ~ 3200	3200	
13.32	第4針的縫製速度。(不夾線) (可以以100sti/min為單位設定) Sewing speed of 4th stitch (Without needle thread clamp) (Speed can be set in a unit of 100 sti/min.)	400 ~ 3200	3200	
14.32	第5針的縫製速度。(不夾線) (可以以100sti/min為單位設定) Sewing speed of 5th stitch (Without needle thread clamp) (Speed can be set in a unit of 100 sti/min.)	400 ~ 3200	3200	
15--	第1針的線張力。(不夾線) Thread tension of 1st stitch (Without needle thread clamp)	0 ~ 200	0	
16--	縫製開始的線張力(不夾線) 變換同步時間 Changeover timing of thread tension at the sewing start (Without needle thread clamp)	-5 ~ 2	-5	
17.0	X/Y 放大縮小率、最高速度限制的顯示以及是否可以進行變更。(防止錯誤操作) Setting whether or not indication or change of X/Y scale rate and max. speed limitation is acceptable. (Prevention of misapplication)	0 : 可以變更 1 : 不能變更 0 : Operative 1 : Inoperative	0	設定 1 時，M 鍵也被禁止使用。 要變更記憶體開關時，請按下M鍵的同時打開(ON)電源。 In case of setting 1, use of M key is prohibited as well. When changing memory switch, pressing M key, turn ON the power switch.
18.1	計數器動作 Counter operation	0 : 生產計數器 (加算) 1 : 底線計數器 (減算) 0 : Production counter (adding) 1 : Bobbin thread counter (subtracting)	0	
19.0	壓腳踏板的選擇 Selection of pedal	0 : 標準踏板 1 : 標準踏板 (2 級行程) 2 : 選購品踏板 3 : 選購品踏板 (2 級行程) 0 : Standard pedal 1 : Standard pedal (2-step stroke) 2 : Optional pedal 3 : Optional pedal (2-step stroke)	0	

顯示 Indication	功能 Function	設定範圍 Setting range	出貨狀態 State when delivered	備考 Remarks
	啟動踏板的選擇 Selection of start pedal	0 : 標準踏板 1 : 選購品踏板 0 : Standard pedal 1 : Optional pedal	0	
	選購品踏板 1 的動作 Optional pedal 1 operation	0 : 再次踩踏板關閉 (OFF) 1 : 腳離開踏板關閉 (OFF) 0 : OFF when depressing pedal again 1 : OFF when detaching from pedal	0	
	選購品踏板 2 動作 Optional pedal 2 operation	0 : 再次踩踏板關閉 (OFF) 1 : 腳離開踏板關閉 (OFF) 0 : OFF when depressing pedal again 1 : OFF when detaching from pedal	0	
	2 級行程時的壓腳高度 Height of work clamp foot at the time of 2-step stroke	50 ~ 90	70	增加設定值之後變低。 Height is lowered when the set value is increased.
	選擇圖案的擴大縮小基準點 Selection of base point of pattern enlargement/reduction	0 : 原點 1 : 縫製開始點 0 : Origin 1 : Sewing start point	0	
	可以用操作盤鍵 (清除鍵) 停止縫紉機動作 Sewing machine operation can be stopped with panel key (clear key).	0 : 無效 1 : 操作盤復位鍵 2 : 外部開關 0 : Ineffective 1 : Panel reset key 2 : External switch	0	
	可以禁止蜂鳴音響 Buzzer sound can be prohibited.	0 : 不響蜂鳴音 1 : 操作盤操作音 2 : 操作盤操作音 + 異常錯誤音 0 : Without buzzer sound 1 : Panel operation sound 2 : Panel operation sound + error sound	2	
	設定夾線開放的針數 Number of stitches that needle thread clamp releases is set.	1 ~ 7針 1 to 7 stitches	2	
	可以推遲夾線的同步時間 Clamping timing of needle thread clamp can be delayed.	-10 ~ 0	0	- 方向變慢。 Timing is delayed in "-" direction.
	可以禁止上線夾線控制 Needle thread clamp control can be prohibited.	0 : 通常 1 : 禁止 0 : Normal 1 : Prohibited	0	防止操作盤的錯誤操作。LKS-1903AN 設定為 1 Misapplication of panel is protected. For LKS-1903AN, set to "1".
	選擇送布動作的同步時間 緊線不好時設定為 - 方向 Feed timing is selected. When stitches are not well-tightened, set the value in "-" direction.	-8 ~ 16	12	向 - 側移動過多的話，有斷針的危險。 縫製厚料時請加以注意。 Setting on excessive "-" side may cause needle breakage. Be careful when sewing heavy-weight material.
	可以選擇縫製結束後的壓腳狀態 State of work clamp foot after completion of sewing can be selected.	0 : 縫製開始移動後，壓腳上升 1 : 縫製結束立即上升 2 : 縫製開始後，踏板上升 0 : Work clamp foot goes up after moving at the sewing start 1 : Work clamp foot goes up immediately after the end of sewing. 2 : Work clamp foot goes up by pedal operation after moving at the sewing start.	1	LKS-1903AN/BR-35設定為 0。 For LKS-1903AN/BR35, set to "0".
	可以設定每次縫製結束後均檢索原點 (除迴圈縫製以外) Execution of origin retrieval every time after completion of sewing can be performed. (Except cycle stitching)	0 : 不檢索原點 1 : 檢索原點 0 : Without origin retrieval 1 : With origin retrieval	0	
	可以設定迴圈縫製時的原點檢索 Setting of origin retrieval in cycle stitching can be set.	0 : 不檢索原點 1 : 每 1 圖案結束 2 : 每 1 迴圈縫製結束 0 : Without origin retrieval 1 : Every time 1 pattern is completed 2 : Every time 1 cycle is completed	0	
	用途中停止命令可以選擇停止後的壓腳狀態 State of work clamp foot when machine stopped by temporary stop command can be selected.	0 : 壓腳上升 1 : 按壓腳開關上升 2 : 禁止壓腳上升 0 : Work clamp foot goes up. 1 : Work clamp foot goes up with work clamp foot switch. 2 : Lift of work clamp foot is prohibited.	0	
	設定針桿停止位置 Needle bar stop position is set.	0 : 上位置 1 : 上死點 0 : UP position 1 : Upper dead point	0	上死點停止時為上位置停止後反轉然後停止。 Needle bar rotates in the reverse direction after the UP position stop and stops when upper dead point stop is set.
	可以禁止切線 Thread trimming can be prohibited.	0 : 待機 1 : 禁止切線 0 : Normal 1 : Thread trimming prohibited	0	

顯示 Indication	功能 Function	設定範圍 Setting range	出貨狀態 State when delivered	備考 Remarks
	可以選擇按清除鍵後的原點返回經由路線 Route of origin return by means of clear key can be selected.	0 : 返回直線 1 : 返回圖案 0 : Straight line return 1 : Reverse return of pattern	0	在從圖案途中返回縫製開始不能直線時使用 This function is used when straight line return from the midway of pattern to the start of sewing is not possible.
	可以設定卷線速度 Bobbin winding speed can be set.	800 ~ 2000	1600	最高速限制被優先 Max. speed limitation has priority
	選擇靠布動作同步時間。僅限 LKS-1901AN Operation timing of material closing is selected. LKS-1901AN only	0 : 禁止輸出 1 : 壓腳下降時動作 2 : 開始時動作 0 : Output prohibited 1 : Operation when work clamp foot comes down, 2 : Operation at the time of start	2	LKS-1901AN以外不能顯示 For the machines other than LKS-1901AN, this function is not indicated.
	可以選擇挑線桿的動作方法 Wiper operation method can be selected.	0 : 中途切線時，沒有挑線器 1 : 中途切線時，有挑線器 ① 2 : 中途切線時，有挑線器 ② 3 : 電磁挑線器 0 : Without wiper at the time of thread trimming on the way 1 : With wiper at the time of thread trimming on the way ① 2 : With wiper at the time of thread trimming on the way ② 3 : Magnet wiper	1	① : 最終挑線桿不返回 ② : 最終挑線桿返回 ① : Without return of the last wiper ② : With return of the last wiper
	可以禁止縫釘鈕扣的縫製開始固定縫製 僅限LKS-1903AN Tie stitching at the start of sewing of the pattern for button sewing can be prohibited. For LKS-1903AN only	0 : 固定縫有效 1 : 固定縫無效 0 : Tie stitching effective 1 : Tie stitching ineffective	0	LKS-1903AN以外不能顯示 For the machines other than LKS-1903AN, thus function is not indicated.
	原點位置為前面 5mm Position of origin moves 5 mm to the front.	0 : 標準 1 : 前面 0 : Standard 1 : Front	0	使用LKS-1904AN的壓腳、圖案時必須進行設定 Necessary to set this function when using work clamp foot and pattern of LKS-1904AN
	設定是否可以讀出圖案資料 This function sets whether or not the calling of the pattern data is operative.	0 : 不能讀出 1 : 可以讀出 0 : Calling inoperative 1 : Calling operative	機種不同則設定也不同 Setting depends on the model used.	可以個別地設定服務圖案No.1 ~ 64 Service pattern Nos. 1 to 64 can be individually set.
	補充潤滑脂時的通知計數器 Grease replenishing time information counter		-	保養請參照「I.[7]-10.向指定部位補充潤滑脂」P.47 Refer to the item "I.[7]-11.Replenishing the designated places with grease" p.47.
	進行圖案登記 Register of the pattern is performed.			請參照「I.[6]-1.使用圖案鍵的縫製」P.29 Refer to the item "I.[6]-1.Performing sewing using the pattern keys" p.29.
	進行迴圈縫製登記 Register of the cycle stitching is performed.			請參照「I.[6]-2.使用組合(複合)的縫製」P.33 Refer to the item "I.[6]-2.Performing sewing using the combination function" p.33.

[9] 其他

[9] OTHERS

1. 設定開關的設定

- SDC 電路板①上的設定開關 SW1 ②設定為 ON 之後，可以加強貫穿力。
- 如果縫製厚料貫穿力不足時，請設定為 ON。其他設定開關全部設定為 OFF。

1. Setting the DIP switch

- When “4” of DIP switch ② on SDC circuit board ① is turned ON, the penetrating force is increased. Turn it ON when the penetrating force is insufficient.
- Turn OFF all DIP switches other than the switch above.

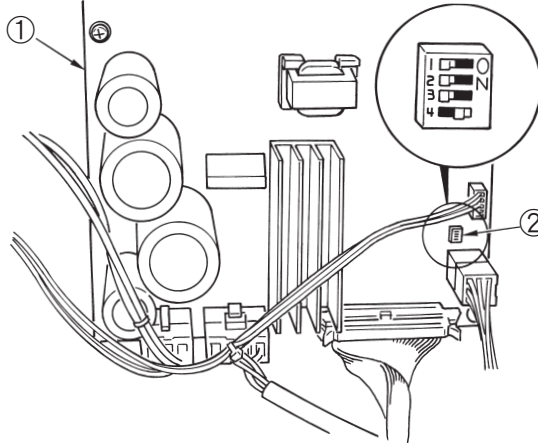
SDC 電路板
SDC p.c.b.

注意：1. 變換設定開關時，請關掉電源之後再進行變換。
2. 請充分注意上軸馬達的發熱。

Caution: 1. Perform the changeover of DIP switch after turning OFF the power.
2. Be very careful of the heat of the main shaft motor.

MAIN 電路板的設定開關全部為 OFF。

Turn OFF all DIP switches of MAIN p.c.b.

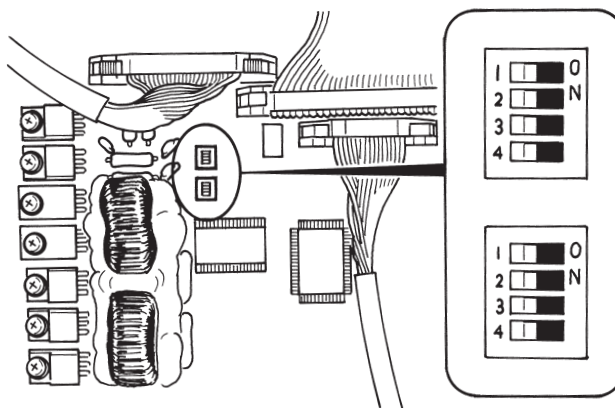
MAIN 電路板
MAIN p.c.b.

2. 標準圖案規格對應表

2. Table of the standard pattern specifications

No.	縱 Lengthwise	橫 Crosswise	針數 Number of stitches	縫製種類 Pattern	S,F,H	M
1(51)	2.0	16	42	大加固Large size bartacking	*	
2	2.0	10	42	大加固Large size bartacking	*	
3	2.5	16	42	大加固Large size bartacking	*	
4	3.0	24	42	大加固Large size bartacking		
5	2.0	10	28	大加固Large size bartacking	*	
6	2.5	16	28	大加固Large size bartacking	*	
7	2.0	10	36	大加固Large size bartacking	*	
8	2.5	16	36	大加固Large size bartacking	*	
9	3.0	24	56	大加固Large size bartacking		
10	3.0	24	64	大加固Large size bartacking		
11	2.5	6	21	小加固 (孔眼) Small size bartacking (eyelet)	*	
12	2.5	6	28	小加固 (孔眼) Small size bartacking (eyelet)	*	
13	2.5	6	36	小加固 (孔眼) Small size bartacking (eyelet)	*	
14	2.0	8	14	針織加固Knit goods bartacking	*	*
15	2.0	8	21	針織加固Knit goods bartacking	*	*
16	2.0	8	28	針織加固Knit goods bartacking	*	*
17	0	10	21	線加固Straight line bartacking	*	
18	0	10	28	線加固Straight line bartacking	*	
19	0	25	28	線加固Straight line bartacking		
20	0	25	36	線加固Straight line bartacking		
21	0	25	41	線加固Straight line bartacking		
22	0	35	44	線加固Straight line bartacking		
23	20	4.0	28	線加固Lengthwise bartacking		
24	20	4.0	36	線加固Lengthwise bartacking		
25	20	4.0	42	線加固Lengthwise bartacking		
26	20	4.0	56	線加固Lengthwise bartacking		
27	20	0	18	縱線加固Lengthwise straight line bartacking		
28	10	0	21	縱線加固Lengthwise straight line bartacking		
29	20	0	21	縱線加固Lengthwise straight line bartacking		
30	20	0	28	縱線加固Lengthwise straight line bartacking		
38	2.0	8	28	針織加固Knit goods bartacking	*	*

出貨狀態可以縫製 * 標記的圖案。

使用此外的標準圖案時，請參照記憶體開關的使用方法「I.[8]-2.(3)是否可以呼出圖案資料的設定」 P.53。

In the condition of delivery from the factory, the pattern sewing with * marks can be made.

When using the standard patterns other than the patterns with * marks, refer to “I.[8]-2.(3) Setting whether the calling of the pattern data is operative or not” p.53 described in the item of the how to use the memory switch.

3. 標準圖案一覽表

3. Table of the standard patterns

	No	落針圖 Stitch diagram	針數 Number of stitches	縫製尺寸(mm) Sewing size(mm)		(注2) 壓腳號碼 (Note 2) No. of work clamp foot
				縱 Length-wise	橫 Cross-wise	
大加 固 Large size bartacking	1 (51)		42	2.0	16	1
						2
						3
	2		42	2.0	10	1
						2
						3
	※ 3		28	2.5	16	1
						4
	※ 4		28	3.0	24	6
						7
5		36	2.0	10	1	
					2	
					3	
※ 6		56	2.5	16	1	
					4	
7		64	2.0	10	1	
					2	
					3	
※ 8		64	2.5	16	1	
					4	
※ 9		64	3.0	24	6	
					7	
※ 10		64	3.0	24	6	
					7	
小加 固 Small size bartacking	11		21	2.5	6	8
	12		28	2.5	6	
	13		36	2.5	6	
針織 加 固 Knit goods bartacking	14		14	2.0	8	5
	15		21	2.0	8	
	16		28	2.0	8	

	No	落針圖 Stitch diagram	針數 Number of stitches	縫製尺寸(mm) Sewing size(mm)		(注2) 壓腳號碼 (Note 2) No. of work clamp foot	
				縱 Length-wise	橫 Cross-wise		
線 加 固 Straight line bartacking	17		28	21	0	10	
							1
							2
	18		28	21	0	10	
							1
							2
	19		36	21	0	25	
							6
	20		36	21	0	25	
							6
21		44	21	0	25		
						6	
22		44	21	0	35		
						(注3) (Note3)	
縱線 加 固 Lengthwise bartacking	23		28	20	4.0	9	
						10	
	24		36	20	4.0	9	
						10	
	25		56	20	4.0	9	
						10	
26		56	20	4.0	9		
					10		
針織 加 固 Knit goods straight line bartacking	27		21	18	20	0	
							11
	28		21	18	10	0	
							11
29		21	18	20	0		
						11	
30		21	18	20	0		
						11	



1. 縫製尺寸為放大率 100% 的尺寸。
2. 壓腳號碼請參照附件壓腳一覽表。
3. No.22 為加工半成品時使用。
4. ※ 標記圖案為縫製牛仔布料用。
5. No.51 為無挑線用。

1. Sewing size shows the dimensions when the scale rate is 100%.
2. Refer the No. of work clamp foot to the separate table of work clamp foot.
3. For No. 22, process the work clamp foot blank for use.
4. Use the patterns with ※ marks for sewing denim.
5. No. 51 is for the machine without thread clamp device.

	No.	落針圖 Stitch diagram	針數 Number of stitches	縫製尺寸 (mm) Sewing size (mm)		(注2) 壓腳號碼 (Note 2) No. of work clamp foot
				縱 Length-wise	橫 Cross-wise	
半月形加固 Semilunar bartacking	31		52	7	10	13
	32		63	7	12	13
	33		24	6	10	13
	34		31	6	12	13
	35		48	10	7	14
	36		48	10	7	14
大加固 Large size bartacking	37		90	3	24	6
						7
針織 加織 Knit goods bartacking	38		28	2	8	5
圓形加固 Round bartacking	39		28	ø12		16
	40		48			



注意 Caution

圖案 No. 41 ~ 46 是選購壓腳 No. 12用。縱加固縫
圖案 No. 23 ~ 26 在原點 5mm 上下不同。

Pattern Nos. 41 to 46 are for the optional work clamp foot No. 12. The origin of the patterns is different by 5 mm up and down from that of lengthwise bartacking pattern Nos. 23 to 26.

	No.	落針圖 Stitch diagram	針數 Number of stitches	縫製尺寸 (mm) Sewing size (mm)		(注2) 壓腳號碼 (Note 2) No. of work clamp foot
				縱 Length-wise	橫 Cross-wise	
縱線加固 Lengthwise bartacking	41		29	20	2.5	12
	42		39	25	2.5	12
	43		45	25	2.5	12
	44		58	30	2.5	12
	45		75	30	2.5	12
	46		42	30	2.5	12
鎖菊 眼花 Radial tacking	47		91	ø8		15
	48		99			
	49		148			
	50		164			

4. 壓腳一覽表

4. Table of the work clamp foot

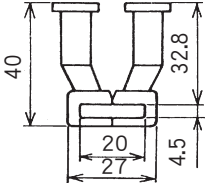
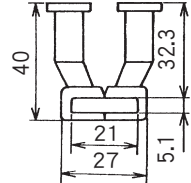
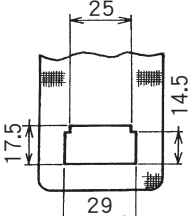
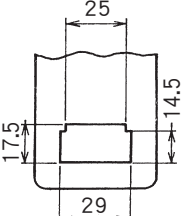
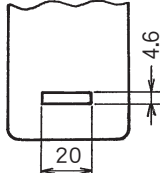
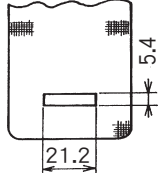
	1	2	3	4
布壓腳 Work clamp foot	P801JK-A (組件 asm.)			P802JK-A (組件 asm.)
				
布壓腳下板 Feed plate	D801JK (有齒牙) (With knurl)	D811JK (無齒牙) (Without knurl)	D821JK (無齒牙) (Without knurl)	D802JK (有齒牙) (With knurl)
				
縫製規格 Sewing specification	S	F	F	H / W
備考 ※ Finger guard	S (標準) 規格機頭上標準裝備。 Standard accessory for S (standard) type machine head.			F (內衣) 規格機頭上裝備。 (根據出口地區) Supplied with F (foundation) type machine head. (Depends on the destination)
				選購品 Optional

※ 更換壓腳時，請安裝適合各壓腳的手指保護器。

※ Install a finger guard suitable for each work clamp foot when replacing the work clamp foot.

	5	6	7	8	9
布壓腳 Work clamp foot	P804JK-A		P805JK-A (組件 asm.)	P806JK-A (組件 asm.)	
布壓腳下板 Feed plate	D804JK (有齒牙) (With knurl)	D814JK (有齒牙) (With knurl)	D832JK (有齒牙) (With knurl)	D838JK (無齒牙) (Without knurl)	D816JK (無齒牙) (Without knurl)
縫製規格 Sewing specification	S	H / W	S	F	F
※手指保護器 ※ Finger guard	BF867JK		—	BF897JK	
備考 Remarks	選購品 Optional	H (厚料) W (倍旋梭) 規格機頭上標準裝備。 Standard accessory for H type (Heavy-weight material) and W type (Double-capacity hook) machine head.	選購品 Optional	F (內衣) 規格選購品。(根據出口地區) Accessory part for F (foundation) type. (Depends on the destination)	

	10	11	12	13	14
布壓腳 Work clamp foot	P808RJK P808LJK	P810RJK P810LJK	P811RJK P811LJK	P812RJK P812LJK	P813RJK P813LJK
布壓腳下板 Feed plate	D808JK (無齒牙) (Without knurl)	D827JK (有齒牙) (With knurl)	D828JK (有齒牙) (With knurl)	D829JK (有齒牙) (With knurl)	D830JK (有齒牙) (With knurl)
縫製規格 Sewing specification	F	S	S	S	S
※手指保護器 ※ Finger guard	BF898JK	—			
備考 Remarks	選購品 Optional	選購品 Optional	選購品 Optional	選購品 Optional	選購品 Optional

※ 更換壓腳時，請安裝適合各壓腳的手指保護器。

※ Install a finger guard suitable for each work clamp foot when replacing the work clamp foot.

5. LKS-1900AN 數據 ROM

- LKS-1900AN 資料 ROM 在插上 MAIN 電路板上的 IC 插頭之後使用。
- 可以使用的 ROM 是 27C256 EPROM 。

注意 :1. 請注意插入當箱。

2. EEPROM 不能使用。
3. 圖案 No. 與標準圖案相同時，數據 ROM 內的圖案優先。

5. LKS-1900AN data ROM

- Insert LKS-1900AN data ROM to the IC socket on MAIN p.c.b for use.
- ROM which can be used :27C256 EPROM

Caution:1. Be careful of the inserting direction.

2. EEPROM cannot be used.
3. When the pattern No. is the same as that of the standard pattern, the pattern in the data ROM is prior to other pattern.

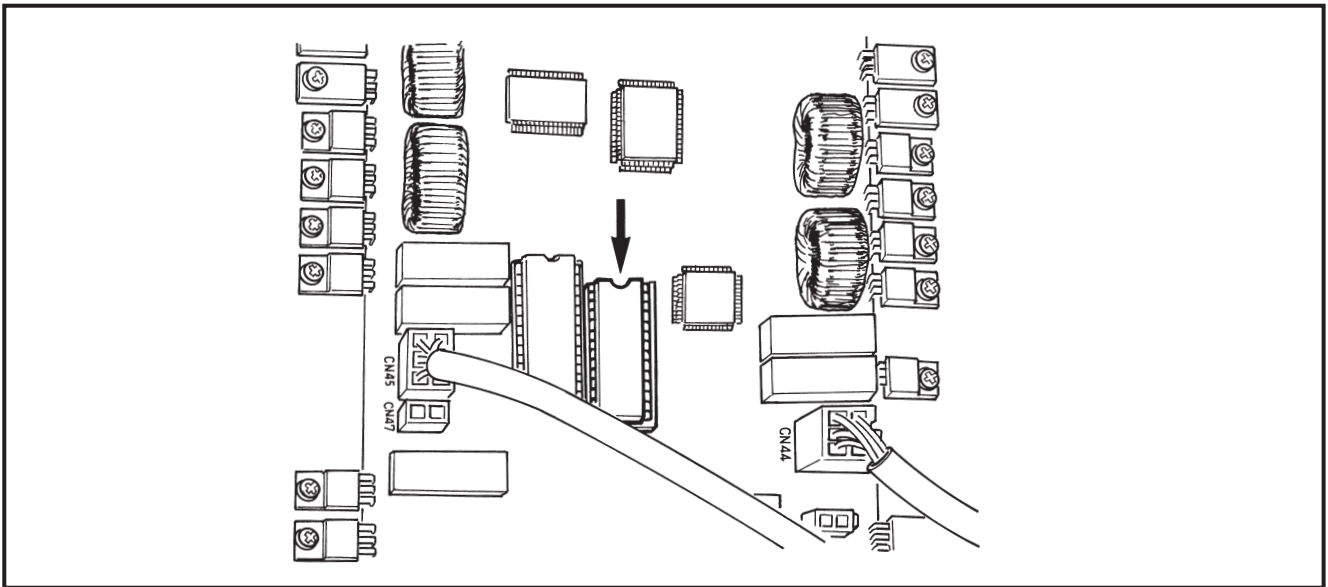

6. 異常一覽表

6. Error list

顯示 Indication	異常名稱 Name of error	異常內容 Description of error	解除方法 Corrective measure	備考 Remarks
	機器鎖定 Machine lock error	因為發生了某些故障，縫紉機主軸不能轉動。 The main shaft of the sewing machine does not rotate due to some troubles.	把電源開關設定為 OFF，排除故障原因。 Turn OFF the power switch and remove the cause of troubles.	
	圖案 No. 異常 Pattern No. error	後備的圖案 No. 沒有被登記到 ROM 裡，或是被設定為不能讀出。圖案 No. 為 0。 Back-uped pattern No. has not been registered in the data ROM, or it is set to readout inoperative. Pattern No. is set to "0".	按重定開關，確認圖案 No.。 確認記憶體開關 No.201 的內容。 Press the reset switch and check the pattern No. Check the contents of memory switch No. 201.	
	針桿位置錯誤 Needle bar position error	針桿沒有在規定的位置。 Needle bar is not in the specified position.	用手轉動手輪，把針桿調整到規定的位置。 Turn the hand pulley to return the needle bar to its specified position.	
	超過縫製區域 Sewing area over	超過縫製區域。 The sewing area is beyond the limit.	按重定開關，確認圖案和 X、Y 擴大率。 Press the reset switch and check the pattern and X/Y scale rate.	超過最大縫製範圍 30 x 40 This error is output when max. sewing area, 30 x 40 is over. Interference of the work clamp foot with needle is not protected.
	擴大異常 Enlargement error	縫製間隔超過 10mm。 The sewing pitch is beyond 10 mm.	按重定開關，確認圖案和 X、Y 擴大率。 Press the reset switch and check the pattern and X/Y scale rate.	
	圖案資料異常 Pattern data error	這是不能對應的圖案資料。 The pattern data cannot be adopted.	關閉 (OFF) 電源，確認資料 ROM。 Turn OFF the power switch and check the data ROM.	
	暫停 Temporary stop	縫紉機運轉中按了重定開關，暫停。 (參照記憶體開關 No.31) Temporary stop by operating the reset switch while the sewing machine is running. (Refer to memory switch No. 31.)	按重定開關切線後，再次開始或返回原點。 (詳細內容請參照 l. (6) -4. 暫停的使用方法, P.37.) Re-start or return-to-origin after thread trimming by means of the reset switch. (For the details, refer to the item "l.[6]-4.How to use the temporary stop", p.37.)	
	機頭識別異常 Machine head identification error	機頭和電氣箱的型號不同。 The type of machine head and the type of control box do not match.	關閉 (OFF) 電源開關，請詢問本公司或者代理商。 Turn the power OFF and contact SIRUBA or your distributor.	
	補充潤滑脂時期的通知 Grease replenishing time information	通知向指定部位補充潤滑脂的時期。 Information as to the time of replenishing the designated places with grease.	向指定部位補充潤滑脂，然後用復位鍵把記憶體開關 No.245 設定為 0。縫製作業中途不能馬上補充潤滑脂時，用復位鍵可以解除異常。 Replenish the designated places with grease and set memory switch No. 245 to "0" with the reset key. Error can be released with the reset key when immediate replenishing with grease cannot be performed during sewing operation.	保養請參照「l. (7) -10. 向指定部位補充潤滑脂」P.47。 Refer to the item "l.[7]-10. Replenishing the designated places with grease" p.47.
	補充潤滑脂警告異常 Grease replenishing warning error	應為到達向指定部位補充潤滑脂的時期，所以縫紉機停止了。 Sewing machine has stopped since the time of replenishing the designated places with grease has come.	請立即補充潤滑脂，然後用重定鍵把記憶體開關 No.245 設定為 0。 Immediately perform replenishing with grease and set memory switch No. 245 to "0" with the reset key.	保養請參照「l. (7) -10. 向指定部位補充潤滑脂」P.47。 Refer to the item "l.[7]-10. Replenishing the designated places with grease" p.47.
	機頭翻倒異常 Head tilt error	機頭翻倒到檢測開關被設定為 ON。 Head tilt detection switch is turned ON.	在放倒機頭的狀態不能運轉。請返回到正常的位置。 The sewing machine cannot be operated with the head tilted. Return the sewing machine head to its proper position.	
	Z 相檢測異常 Z phase detection error	不能檢測縫紉機的上死點。 Detection of the upper dead point of the sewing machine cannot be performed.	關閉 (OFF) 電源開關，拔掉 SDC 電路板 CN14，確認是否鬆動脫落。 Turn OFF the power switch and check whether CN14 of SDC circuit board is disconnected or loose.	
	切線切刀位置異常 Thread trimmer position error	切線刀不在正確位置。 The thread trimmer is not in the proper position.	關閉 (OFF) 電源開關，拔掉 INT 電路板 CN66，確認是否鬆動脫落。 Turn OFF the power switch and check whether CN66 of INT circuit board is disconnected or loose.	
	夾線裝置異常 Needle thread clamp position error	夾線裝置不在正確位置。 The needle thread clamp device is not in the proper position.	關閉 (OFF) 電源開關，確認 INT 電路板 CN65 是否鬆動、脫落。 Turn OFF the power switch and check whether CN65 of INT circuit board is disconnected or loose.	

顯示 Indication	異常名稱 Name of error	異常內容 Description of error	解除方法 Corrective measure	備考 Remarks
E 7300	變換器不良 A Encoder trouble A	變換器 A、B 不能檢測 Encoder A or B phase cannot be detected.	關閉 (OFF) 電源，確認 CN14 是否鬆動、脫落。 Turn OFF the power switch and check whether CN14 is loose or disconnected.	
E 7311	變換器不良 B Encoder trouble B	變換器 U、V、W 相不能檢測 Encoder U, V or W phase cannot be detected.	關閉 (OFF) 電源，確認 CN14 是否鬆動、脫落。 Turn OFF the power switch and check whether CN14 is loose or disconnected.	
E 7333	馬達倒轉 Reverse rotation of motor	馬達倒轉 The motor is reversing.	關閉 (OFF) 電源開關，確認主馬達的杯環是否鬆動。 Turn OFF the power switch and check whether coupling of the main motor is loose.	
E 8111	電壓過高異常 Overvoltage error	電源電壓超過規定值 Power source voltage is beyond the specified value.	確認電源電壓 Check the power source voltage.	
E 8113	電壓過低異常 Low voltage error	電源電壓不足 Power source voltage is short.	確認電源電壓 Check the power source voltage.	
E 9001	馬達驅動器不良 Motor driver trouble	馬達驅動器檢測出異常 Error from the motor driver is detected.	關閉 (OFF) 電源，稍待一些時間後再次打開 (ON) 電源 Turn OFF the power switch and turn ON the power switch again after some time.	
E 9003	步進馬達電源異常 Stepping motor power source trouble	步進馬達的電源不輸出 Power source of the stepping motor is not output.	關閉 (OFF) 電源，確認 SDC 電路板 F1 保險絲 Turn OFF the power switch and check F1 fuse of SDC circuit board.	檢查斷保險絲的原因 Check the cause of blown-out of the fuse.
E 9004	繼電器電源異常 Solenoid power source trouble	繼電器的電源不輸出 Power source of the solenoid is not output.	關閉 (OFF) 電源，確認 SDC 電路板 F2 保險絲 Turn OFF the power switch and check F2 fuse of SDC circuit board.	檢查斷保險絲的原因 Check the cause of blown-out of the fuse.
E 9005	SDC 電路板過熱 SDC circuit board overheat	SDC 電路板過熱 Overheat of SDC circuit board	關閉 (OFF) 電源，稍待一些時間後再次打開 (ON) 電源 Turn OFF the power switch and turn ON the power switch again after some time.	
E 9007	X 原點檢索異常 X origin retrieval error	X 原點感測器不變化 X origin sensor does not change.	關閉 (OFF) 電源開關，確認 INT 電路板 CN62、電路板 CN42 是否鬆動、脫落。 Turn OFF the power switch and check whether CN62 of INT circuit board or CN42 of MAIN circuit board is disconnected or loose.	
E 9008	Y 原點檢索異常 Y origin retrieval error	Y 原點感測器不變化 Y origin sensor does not change.	關閉 (OFF) 電源開關，確認 INT 電路板 CN63、電路板 CN43 是否鬆動、脫落。 Turn OFF the power switch and check whether CN63 of INT circuit board or CN43 of MAIN circuit board is disconnected or loose.	
E 9110	壓腳原點檢索異常 Work clamp foot origin retrieval error	壓腳原點感測器不變化 Work clamp foot origin sensor does not change.	關閉 (OFF) 電源開關，確認 INT 電路板 CN64、電路板 CN44 是否鬆動、脫落。 Turn OFF the power switch and check whether CN64 of INT circuit board or CN44 of MAIN circuit board is disconnected or loose.	
E 9113	夾線原點檢索異常 Needle thread clamp origin retrieval error	夾線原點感測器不變化 Needle thread clamp origin sensor does not change.	關閉 (OFF) 電源開關，確認 INT 電路板 CN65、電路板 CN45 是否鬆動、脫落。 Turn OFF the power switch and check whether CN65 of INT circuit board or CN45 of MAIN circuit board is disconnected or loose.	
E 9114	傳送不良異常 Feed trouble error	送布和主軸不同步 Timing lag between feed and main shaft has occurred.	關閉 (OFF) 電源開關，確認主馬達的杯環是否鬆動 Turn OFF the power switch and check whether coupling of the main motor is loose.	

顯示 Indication	異常名稱 Name of error	異常內容 Description of error	解除方法 Corrective measure	備考 Remarks
	操作盤 ~ MAIN 電路板通信異常 Communication error between panel and MAIN circuit board	操作盤 ~ MAIN 電路板不能通信 Communication between the panel and MAIN circuit board cannot be performed	關閉 (OFF) 電源開關，確認 MAIN 電路板 CN34 是否鬆動。 Turn OFF the power switch and check whether CN34 of MAIN circuit board is loose.	
	MAIN 電路板 ~ SDC 電路板通信異常 Communication error between panel and SDC	MAIN 電路板 ~ SDC 電路板不能通信 Communication between MAIN circuit board and SDC cannot be performed	關閉 (OFF) 電源開關，確認 MAIN 電路板 CN32、SDC 電路板 CN15 是否鬆動、脫落。 Turn OFF the power switch and check whether CN32 of MAIN circuit board or CN15 of SDC circuit board is disconnected or loose.	
	MAIN 電路板過熱 MAIN circuit board overheat	MAIN 電路板過熱 Overheat of MAIN circuit board	關閉 (OFF) 電源，稍待一些時間後再次打開 (ON) 電源。 Turn OFF the power switch and turn ON the power switch again after some time.	
	MAIN 記憶體寫入不良 MAIN memory write-in trouble	MAIN 電路板不能寫入 Memory write-in of MAIN circuit board cannot be performed.	關閉 (OFF) 電源開關，確認 MAIN 電路板 U22 的 ROM 是否鬆動。 Turn OFF the power switch and check the insertion of ROM of U22 of MAIN circuit board.	
	INT 記憶體寫入不良 INT memory write-in trouble	機頭電路板記憶體不能寫入 Memory write-in of the head circuit board cannot be performed.	關閉 (OFF) 電源開關，確認 MAIN 電路板 CN38 是否鬆動、脫落。 Turn OFF the power switch and check whether CN38 of MAIN circuit board is disconnected or loose.	
 (無顯示) (Without indication)	電源異常 插頭脫落 Abnormal power source Disconnection of connector	電源電壓規格不對 插頭脫落 Power source voltage type is different. The connector is disconnected.	關閉 (OFF) 電源開關，確認電源電壓和 INT 電路板 CN3、SDC 電路板 CN13 是否鬆動、脫落。 Turn OFF the power switch and check the power source voltage and check whether CN3 of FLT circuit board or CN13 of SDC circuit board is disconnected or loose.	

7. 縫製時的故障、原因和對策

7. Troubles and corrective measures
(sewing conditions)

現象 Trouble	原因 Cause	對策 Corrective measures	頁 Page
1. 始縫時脫線 1. The needle thread slips off at the start of bar-tacking.	① 始縫時跳針。	◎ 機針和旋梭的間隙調整為 0.05 ~ 0.1mm。	42
	② 切線後上線長度太短。	◎ 設定始縫時緩起動。	49
	③ 底線過短。	◎ 調節第 2 線張力器的浮線量。	18
	④ 第 1 針的上線張力太高。	◎ 把挑線彈簧弄強或把第一線張力盤的張力減弱。	17
	⑤ 夾線不穩定(布料容易伸長、線不滑、線粗等)	◎ 減弱底線張力。	44
	⑥ 第 1 針的間距小。	◎ 弄大針孔導向器和固定刀的間隙。 ◎ 降低第 1 針的張力。 ◎ 降低縫製開始第 1 針的轉速。(600 ~ 1000sti/min 左右)	42
2. 常斷線 化纖線拉斷 2. Thread often breaks or synthetic fiber thread splits finely.	① Stitches are slipped at the start.	◎ 夾線針數增加 3 ~ 4 針。 ◎ 增長第 1 針的間距。 ◎ 下降第 1 針的上線張力。	42
	② The needle thread remaining on the needle after thread trimming is too short.	◎ Adjust the clearance between the needle and the shuttle to 0.05 to 0.1 mm.	49
	③ The bobbin thread is too short.	◎ Set soft-start sewing at the start of bartacking.	18
	④ Needle thread tension at 1st stitch is too high.	◎ Correct the thread tension release timing of the thread tension controller No. 2.	17
	⑤ Thread clamp is unstable (material is apt to be expanded, thread is hard to slide, thread is thick, etc.).	◎ Increase the tension of the thread take-up spring, or decrease the tension of the thread tension controller No. 1.	44
	⑥ Pitch at 1st stitch is too small.	◎ Decrease the tension of the bobbin thread. ◎ Increase the clearance between the needle hole guide and the counter knife. ◎ Decrease the tension at 1st stitch. ◎ Decrease the number of rotation at 1st stitch at the sewing start. (Extent of 600 to 1,000 sti/min) ◎ Increase the number of stitches of thread clamp to 3 to 4 stitches. ◎ Make the pitch at 1st stitch longer. ◎ Decrease the needle thread tension at 1st stitch.	43
3. 常斷針 3. The needle often breaks.	① 旋梭、驅動器上有傷。	◎ 卸下用細磨時或銼刀磨平。	17
	② 針孔導向器上有傷。	◎ 用銼刀磨，或換新。	17
	③ 機針碰布壓腳。	◎ 調節布壓腳的位置。	13
	④ 線頭進入大旋梭的溝裡。	◎ 卸下中旋梭，清除線頭。	43
	⑤ 上線張力過強。	◎ 減弱上線張力。	17
	⑥ 挑線彈簧過強。	◎ 減弱挑線彈簧。	17
	⑦ 化纖線磨熱而斷。	◎ 使用矽油。	13
4. 線切不斷 4. Threads are not trimmed.	① The shuttle or the driver has scratches.	◎ Take it out and remove the scratches using a fine whetstone or buff.	43
	② The needle hole guide has scratches.	◎ Buff or replace it.	43
	③ The needle strikes the work clamp foot.	◎ Correct the position of the work clamp foot.	17
	④ Fibrous dust is in the groove of the shuttle race.	◎ Take out the shuttle and remove the fibrous dust from the shuttle race.	17
	⑤ The needle thread tension is too high.	◎ Reduce the needle thread tension.	13
(僅限底線) (Bobbin thread only)	⑥ The tension of the thread take-up spring is too high.	◎ Reduce the tension.	14
	⑦ The synthetic fiber thread melts due to heat generated on the needle.	◎ Use silicone oil.	43
	① 針彎了。	◎ 更換機針。	43
	② 針碰布壓腳。	◎ 調節布壓腳。	40
	③ 針過粗。	◎ 根據縫製物選用適當的機針。	45
3. 常斷針 3. The needle often breaks.	④ 驅動器把針弄得過彎。	◎ 調整針和旋梭位置。	14
	⑤ 在縫製開始時壓腳壓住縫紉機線(機針彎曲)。	◎ 調整針和旋梭的距離。(23~25mm)	43
	① The needle is bent.	◎ 更換機針。	43
	② The needle hits the work clamp foot.	◎ Correct the position of the work clamp foot.	43
	③ The needle is too thin for the material.	◎ Replace it with a thicker needle according to the material.	40
4. 線切不斷 4. Threads are not trimmed.	④ The driver excessively bends the needle.	◎ Correctly position the needle and the shuttle.	40
	⑤ Needle thread is stepped on by the work clamp foot at the start of sewing. (Needle bend)	◎ Widen the distance between the needle and the wiper. (23 to 25 mm)	45
	① 固定刀不鋒利。	◎ 更換固定刀。	44
	② 針孔導向器和固定刀高低差小。	◎ 把固定刀再弄彎一些。	40
	③ 動刀位置不好。	◎ 調整動刀位置。	44
(僅限底線) (Bobbin thread only)	④ 最終針跳線。	◎ 調整針和旋梭的同步。	40
	⑤ 底線張力低。	◎ 高底線張力。	40
	① The counter knife is dull.	◎ Replace the counter knife.	44
	② The difference in level between the needle hole guide and the counter knife is not enough.	◎ Increase the bend of the counter knife.	44
	③ The moving knife has been improperly positioned.	◎ Correct the position of the moving knife.	40
(僅限底線) (Bobbin thread only)	④ The last stitch is skipped.	◎ Correct the timing between the needle and the shuttle.	40
	⑤ Bobbin thread tension is too low.	◎ Increase the bobbin thread tension.	40

現象 Trouble	原因 Cause	對策 Corrective measures	頁 Page
5. 常跳線 5. Stitch skipping often occurs.	<ul style="list-style-type: none"> ① 針和旋梭調整不好。 ② 針和中旋梭的間隙過大。 ③ 針彎了。 ④ 驅動器把針弄得過彎。 ① The motions of the needle and shuttle are not properly synchronized. ② The clearance between the needle and shuttle is too large. ③ The needle is bent. ④ The driver excessively bends the needle. 	<ul style="list-style-type: none"> ◎ 調整針和旋梭的位置。 ◎ 調整針和旋梭的位置。 ◎ 更換機針。 ◎ 調整驅動器的位置。 ◎ Correct the positions of the needle and shuttle. ◎ Correct the positions of the needle and shuttle. ◎ Replace the bent needle. ◎ Correctly position the driver. 	<p>40 40 14 40 40</p> <p>40 14 40</p>
6. 上線從布的裡側露出來。 6. The needle thread comes out on the wrong side of the material.	<ul style="list-style-type: none"> ① 上線張力不好。 ② 線張力盤浮起機構不動作。 ③ 切線後的上線過長。 ④ 針數少。 ⑤ 縫製長度短時（縫製背面上線頭露出。） ⑥ 針數少。 ① The needle thread tension is not high enough. ② The tension release mechanism fails to work properly. ③ The needle thread after thread trimming is too long. ④ Number of stitches is too few. ⑤ When sewing length is short (End of needle thread protrudes on the wrong side of sewing product.) ⑥ Number of stitches is too few. 	<ul style="list-style-type: none"> ◎ 加強上線張力。 ◎ 確認縫製中第 2 線張力盤是否浮起。 ◎ 加強第 1 線張力。 ◎ 把夾線裝置設定為 OFF。 ◎ 把夾線裝置設定為 OFF。 ◎ 使用暗縫式下板。 ◎ Increase the needle thread tension. ◎ Check whether or not the tension disc No. 2 is released during bar-tracking. ◎ Increase the tension of the thread tension controller No. 1. ◎ Correct the position of the moving knife. ◎ Turn OFF the thread clamp. ◎ Turn OFF the thread clamp. ◎ Use the lower plate, the hole of which is larger than the presser. 	<p>17</p> <p>17</p> <p>17</p> <p>17</p>
7. 切線時斷線 7. Threads break at time of thread trimming.	<ul style="list-style-type: none"> ① 動刀位置不正確。 ① The moving knife has been improperly position. 	<ul style="list-style-type: none"> ◎ 調節動刀位置。 ◎ Correct the position of the moving knife. 	<p>44 44</p>
8. 上線纏結在夾線裝置上 8. The thread clamp is entangled with needle thread.	<ul style="list-style-type: none"> ① 縫製開始的上線太長。 ① The needle thread at the sewing start is too long. 	<ul style="list-style-type: none"> ◎ 鎖緊第 1 線張力器，把機線長度調整為 33 ~ 36mm。 ◎ Tighten thread tension controller No. 1 and make the length of needle thread 33 to 36mm. 	
9. 機線長度不一致 9. Uneven length of the needle thread	<ul style="list-style-type: none"> ① 挑線彈簧的張力太低。 ① The tension of thread take-up spring is too low. 	<ul style="list-style-type: none"> ◎ 提高挑線彈簧的張力。 ◎ Increase the tension of the thread take-up spring. 	
10. 機線長度不能弄短 10. The length of needle thread does not become short.	<ul style="list-style-type: none"> ① 第 1 線張力器的張力太低。 ② 挑線彈簧張力過強。 ③ 因為挑線彈簧的張力過低，所以動作不穩定。 ① The tension of thread tension controller No. 1 is too low. ② The tension of thread take-up spring is too high. ③ The tension of thread take-up spring is too low and motion is unstable. 	<ul style="list-style-type: none"> ◎ 增強第 1 線張力器的張力。 ◎ 降低挑線彈簧的張力。 ◎ 增強挑線彈簧的張力，行程也變長。 ◎ Increase the tension of thread tension controller No. 1. ◎ Decrease the tension of thread take-up spring. ◎ Increase the tension of thread take-up spring and lengthen the stroke as well. 	
11. 縫制開始第2針的底線結線部露出表面 11. The knotting section of bobbin thread at 2nd stitch at the sewing start appears on the right side.	<ul style="list-style-type: none"> ① 梭芯的空轉大。 ② 底線張力太低。 ③ 第 1 針的上線張力過強。 ① Idling of bobbin is large. ② The bobbin thread tension is too low. ③ The needle thread tension at 1st stitch is too high. 	<ul style="list-style-type: none"> ◎ 調整活動刀位置。 ◎ 增強底線張力。 ◎ 下降第 1 針的上線張力。 ◎ 把夾線裝置設定為 OFF。 ◎ Adjust the position of the moving knife. ◎ Increase the bobbin thread tension. ◎ Decrease the needle thread tension at 1st stitch. ◎ Turn OFF the thread clamp. 	

8. 選購品零件一覽表

8. Table of the optional parts

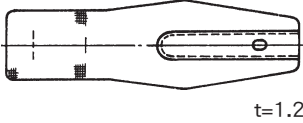
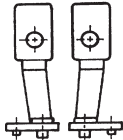
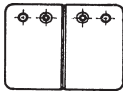
零件名稱 Name of Parts	種類 Type	貨號 Part No.	備考 Remarks
布壓腳下板夾 Feed plate blank 	無齒牙／有表面處理 縫製範圍 縱 20× 橫 40 Without knurl / processed Sewing area lengthwise 20 X crosswise 40	D818JK	
	有齒牙／有表面處理 縫製範圍 縱 20× 橫 40 With knurl / processed Sewing area lengthwise 20 X crosswise 40	D819JK	t=0.5
	無齒牙／不銹鋼 縫製範圍 縱 20× 橫 40 Without knurl / stainless steel Sewing area lengthwise 20 X crosswise 40	D820JK	
	有齒牙／有表面處理 縫製範圍 縱 30× 橫 40 Without knurl / processed Sewing area lengthwise 30 X crosswise 40	D839JK	
	有齒牙／無表面處理 縫製範圍 縱 30× 橫 40 Without knurl / without processing Sewing area lengthwise 30 X crosswise 40	D822JK	
壓腳滑板（組件） Work clamp foot face plate (asm.) 		P814JK-A	布壓腳夾用滑板 Face plate for presser blank
布壓腳夾 Presser blank 	有齒牙／有表面處理（右） 縫製範圍 縱 20× 橫 40 With knurl / Processed (right) Sewing area lengthwise 20 X crosswise 40	D835RJK	
	有齒牙／有表面處理（左） 縫製範圍 縱 20× 橫 40 With knurl / Processed (Left) Sewing area lengthwise 20 X crosswise 40	D835LJK	
	有齒牙／有表面處理（右） 縫製範圍 縱 30× 橫 40 With knurl / Processed (right) Sewing area lengthwise 30 X crosswise 40	D836RJK	
	有齒牙／有表面處理（左） 縫製範圍 縱 30× 橫 40 With knurl / Processed (Left) Sewing area lengthwise 30 X crosswise 40	D836LJK	
	有齒牙／無表面處理（右） 縫製範圍 縱 30× 橫 40 With knurl / without processing (right) Sewing area lengthwise 30 X crosswise 40	D837RJK	
	有齒牙／無表面處理（左） 縫製範圍 縱 30× 橫 40 With knurl / without processing (Left) Sewing area lengthwise 30 X crosswise 40	D837LJK	

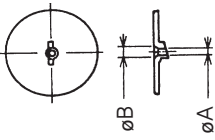
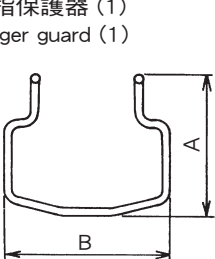
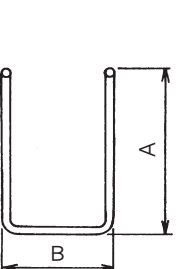
零件名稱 Name of Parts	種類 Type	貨號 Part No.	備考 Remarks
針孔導向器 Needle hole guide 	A=2.3 B=4.0 無槽 Without relief slit	E152JK	H. W 規格 H and W types
手指保護器 (1) Finger guard (1) 	A=59 B=74	BF867JK	大擺動用 For large size bartacking
手指保護器 (2) Finger guard (2) 	A=66.5 B=43	BF897JK	縱加固用 For lengthwise bartacking



 高林股份有限公司
KAULIN MFG. CO., LTD.

由於對產品的改良及更新，本產品使用說明書中與零件圖之產品及外觀的修改恕不事先通知！
The specification and/or appearances of the equipment described in this instruction book & parts list are subject to change because of modification which will without previous notice.
LKS-1900AN.NOV.2015